

42

AWARD
Tech Report
Series

Overview of Wastewater Treatment in South Africa

Katy Hansen
March 2015



USAID
FROM THE AMERICAN PEOPLE

SOUTHERN AFRICA



Acknowledgements

The USAID: RESILIM-O project is funded by the U.S. Agency for International Development under USAID/Southern Africa RESILIENCE IN THE LIMPOPO BASIN PROGRAM (RESILIM). The RESILIM-O project is implemented by the Association for Water and Rural Development (AWARD), in collaboration with partners. Cooperative Agreement nr AID-674-A-13-00008.

© Association for Water and Rural Development (AWARD)

Author

Katy Hansen

March 2015

Association for Water and Rural Development (AWARD)

P O Box 1919

Hoedspruit 1380

Limpopo, South Africa

T 015-793 0503

W award.org.za

Company Reg. No. 98/03011/08



Table of Contents

List of Acronyms	4
1 Introduction	5
2 Overview of key concepts.....	5
2.1 Background on wastewater	5
2.2 Wastewater Treatment	7
2.2.1 Collection and transport	7
2.2.2 Pre-treatment or Preliminary treatment.....	9
2.2.3 Primary treatment	10
2.2.4 Secondary treatment	11
2.2.5 Tertiary treatment	14
2.2.6 Discharge.....	15
2.3 Managing Wastewater Treatment Works.....	16
2.3.1 Planning	16
2.3.2 Operating	17
2.3.3 Monitoring	19
2.3.4 Maintaining	21
2.3.5 Risk abatement and disaster management	26
2.3.6 Financing.....	27
3 Wastewater Governance in South Africa	30
3.1 How WWTW fits into Water Resource Management in South Africa	30
3.2 History	31
3.3 Organization's Roles and Responsibilities	34
3.3.1 District and Local Municipalities.....	34
3.3.2 Water Services Authorities (WSAs) & Water Services Providers (WSPs).....	34
3.3.3 Water Utilities or Water Boards	35
3.3.4 Department of Water and Sanitation	36
3.3.5 Department of Cooperative Governance and Traditional Affairs (COGTA)	36
3.3.6 South African Local Government Association (SALGA)	36
3.3.7 National Treasury	36
3.3.8 Other national departments.....	37
3.4 Rules, norms and standards	38
3.4.1 Legislation	38
3.4.2 Policy	40



4	Institutional framework	40
5	Factors determining institutional arrangements	42
	5.1.1 Plans	44
	5.1.2 Strategies & guidelines	46
	5.2 Regulation	47
	5.2.1 Limits and Standards	47
	5.2.2 Regulation	49
	5.3 Compliance, monitoring and enforcement	54
6	Works Cited	55
7	Additional References	56

List of Tables

Table 1: Constituent of wastewater and potential harm caused if not treated	6
Table 2: Operational practices associated with steps of the wastewater treatment process.	18
Table 3: Estimated number of process controllers required to effectively operate the micro, small and medium wastewater treatment plans in South Africa	19
Table 4: The MIG allocation for water and sanitation (R billion)	28
Table 5: Equitable Share for water and sanitation (R billion) per province	29
Table 6: Effluent Discharge Standards	48
Table 7: Key requirements for Green Drop Criteria (Green Drop Introduction, 2011)	50
Table 8: Colour codes and appropriate action by municipality for performance areas assessed for Green Drop Certification	53



List of Figures

Figure 1: Schematic of an activated sludge wastewater treatment process	7
Figure 2: Initial WW flow	8
Figure 3: Lift station	8
Figure 4: Bad screens	9
Figure 5: Primary clarifier	10
Figure 6: Grease balls forming in the wet well	10
Figure 7: Types of secondary treatment in SA	11
Figure 8: Schematic of a Typical Conventional Activated Sludge Wastewater Treatment Process...	12
Figure 9: Anoxic and oxic zones of an aeration chamber	12
Figure 10: Poorly maintained rotating biological contactors (SOURCE: Boyd & Mbelu, 2009).....	13
Figure 11: Schematic of generic anaerobic pond system process	14
Figure 12: Photos of bad oxidation ponds.....	14
Figure 13: Bad final effluent.	16
Figure 14: Graphic identification of inflow	17
Figure 15: Illustration of diurnal wastewater flow, BOD, and mass loading variability.....	21
Figure 16: Example of good maintenance	23
Figure 17: Example of bad maintenance	23
Figure 18: Example of a checklist	24
Figure 19: The Asset Management Cycle	25
Figure 20: Percentage of WWTW in SA with problems with maintenance	26
Figure 21: Municipal Grant Funding.	27
Figure 22: Resources deployed on wastewater treatment plans.....	30
Figure 23: Water services lifecycle	31
Figure 24: Community Sanitation Needs	33
Figure 25: Household Sanitation Census data	33
Figure 26: Water Service Authorities by Type.....	35
Figure 27: Linkages between the most essential municipal business processes.	44



List of Acronyms

AWARD	Association for Water and Rural Development
BOD	Biochemical Oxygen Demand
CC	Climate Change
CH ₄	Methane
CO ₂	Carbon Dioxide
COD	Chemical Oxygen Demand
DO	Dissolved oxygen
DWA	Department of Water Affairs (renamed DWAS)
DWAF	Department of Water Affairs and Forestry
DWAS	Department of Water Affairs and Sanitation (previously named DWA)
ELU	Existing Lawful Use
GA	General Authorisation
GD	Green Drop
kℓ	Kilolitre (1 kℓ of water = 1 000 litres of water)
M	Metres
m/s	Metres/second
m ³	Cubic metres (1 m ³ of water = 1000 litres of water)
Mℓ	Megalitre (1 Mℓ water = 1 000 000 litres of water)
MLSS	Mixed Liquor Suspended Solids
NH ₃	Ammonia
NWA	National Water Act
OHSA	Occupational Health and Safety Act
ORB	Olifants River Basin
PPE	Personal protective equipment
PST	Primary Sedimentation/settling Tank
RAS	Return Activated Sludge
RBC	Rotating biological contactors
RESILIM	Resilience in the Limpopo
s	Seconds
SRT	Solids Retention Time (sludge age)
SS	Suspended Solids
TDS	Total Dissolved Solids
TS	Total Solids
VS	Volatile Solids
WAS	Waste Activated Sludge
WSA	Water Services Act
WUL	Water Use Licence
WWTW	Wastewater treatment work



1 Introduction

Based on a literature review, this report explains key concepts and practices associated with wastewater treatment and outlines wastewater management and governance in South Africa. The basic components of wastewater treatment—from collection and transport to treatment and discharge—are described along with major managerial and operational tasks, including planning, operating, monitoring, maintaining, and financing. The section on management and governance explains how wastewater treatment fits into water resource management in South Africa and describes organizational roles and responsibilities and rules, norms and standards associated with wastewater treatment.

The purpose of this report is to provide a background information on the context for RESILIM-O's collaborative work with municipalities to improve wastewater treatment works management in the Olifants River Basin. Understanding the context is the first step towards improving practices. This report is the first step towards the aim to mitigate the impact of wastewater on water resources, especially water quality.

2 Overview of key concepts

2.1 Background on wastewater

Raw wastewater is hazardous and must be treated to prevent impacts on water resources and public health and safety. Wastewater is treated to improve the physical, chemical, and microbiological quality of water. The World Bank (2014) explains that treatment aims to reduce suspended solids, nutrients, such as nitrates and phosphates, biodegradable organics, and pathogenic bacteria, among others.

Van der Merwe-Botha (2011) explains in the 'Wastewater Risk Abatement Plan Guidelines' "[m]ost of the potential hazards relating to the discharge of effluent into the receiving resource environment, either through direct discharge or through irrigation, relate to ineffective treatment, which thus creates a hazard potential to either the downstream user of the river and or environment (pg. 53)." Table 1 shows the constituents of wastewater and potential harm caused if not treated.



TABLE 1: CONSTITUENT OF WASTEWATER AND POTENTIAL HARM CAUSED IF NOT TREATED

SUBSTANCE/ PARAMETER	WHY IT'S IMPORTANT
BIODEGRADABLE ORGANICS (BOD AND COD)	Composed of proteins, carbohydrates, and fats, biodegradable organics serve as “food” for microorganisms living in watercourses. “Microorganisms combine this matter with oxygen from the water to yield the energy they need to thrive and multiply; unfortunately, this oxygen is also needed by fish and other organisms in the river. Heavy organic pollution can lead to “dead zones” where no fish can be found; sudden releases of heavy organic loads can lead to dramatic “fish kills” (World Bank Group, 2014).” Biodegradable organics are measured in terms of the oxygen required by bacteria to oxidise organic material to carbon dioxide and water (biochemical oxygen demand (BOD)) and an organic compound to carbon dioxide, ammonia, and water (chemical oxygen demand (COD)).
COLOUR, ODOR OR TASTE	
ELECTICAL CONDUCTIVITY (MILISEIEMENS/ METER (MS/M))	“Electrical Conductivity (EC) is the measure of the ease with which water conducts electricity and gives an indication of the total dissolved salt (TDS) content of the water. Health effects related to EC occur at levels above about 370 mS/m (https://www.wqms.co.za/infopages/211).”
FREE CHLORINE (MG/L)	“Free chlorine residual is an indication of the efficiency of the disinfection process and is thus a rapid indicator of the probable microbiological safety or otherwise of the treated water. [...] Absence of residual chlorine means either that the water was not treated with chlorine, or that insufficient chlorine was used to successfully disinfect the water. Where the untreated water contains pathogenic microorganisms, the absence of free residual chlorine indicates that there is a risk of microbial infection. However, if the concentration of chlorine is too high then irritation of mucous membranes, nausea and vomiting may occur (https://www.wqms.co.za/infopages/211).”
NUTRIENTS, INCLUDING NITRATES AND PHOSPHATES.	“Both nitrogen and phosphorus, along with carbon, are essential nutrients for growth. When discharged to the aquatic environment, these nutrients can lead to the growth of undesirable aquatic life (Cheremisinoff, 1994)” such as unwanted algae. “When discharged in excessive amounts on land, they can also lead to the pollution of groundwater (Cheremisinoff, 1994).”
PATHOGENS (PATHOGENIC BACTERIA AND OTHER DISEASE CAUSING ORGANISMS)	“Communicable diseases can be transmitted by pathogenic organisms that may be present in wastewater (Cheremisinoff, 1994).” For example, faecal coliform pollution carries pathogens. This is a concern when the receiving water is used for drinking or recreational purposes, when people are in close contact with it (World Bank). The presence of <i>E. coli</i> , an organism found in feces, indicates total coliform present in wastewater.
PH	“The main significance of pH in domestic water supplies relates to its effects on water treatment processes. The pH of water can be adjusted up or down by the addition of an alkali or an acid (van der Merwe-Botha and Manus, 2011).”
SOAP, OIL OR GREASE (MG/L)	Soap, oil and grease is detrimental to wastewater treatment.
SUSPENDED SOLIDS	“Suspended solids can lead to the development of sludge deposits and anaerobic conditions when untreated wastewater is discharged to the aquatic environment (Cheremisinoff, 1994).”
TEMPERATURE	
TURBIDITY	“As the turbidity of water increases, the amount of chlorine required for disinfection of the water increases. Low turbidity therefore minimizes the required chlorine dose and reduces the formation of chloro-organics that often give rise to taste and odour problems and trihalomethanes. Due to the many advantages associated with water of low turbidity and the relative ease of monitoring, it is often used as an indicator of potential water quality problems during treatment (van der Merwe-Botha and Manus, 2011).”

2.2 Wastewater Treatment

“The function of a waterborne sanitation system is to collect and convey wastewater in a hygienic manner. Operation and maintenance of this sewer system means making sure that all its components are kept in good operating condition. Planners, designers, the construction team and the administrators have a joint duty in providing an efficient system. The operator can then, based on the available resources provided, operate and maintain the system.”

-Dijk & Vuuren (2011)

This section reviews key concepts for understanding wastewater treatment and the operation and management of municipal WWTW, including typical challenges. The overview is limited to large-scale wastewater treatment plants and does not include household wastewater or sanitation systems (e.g. VIPs, septic tanks). After collection and transport to the plant, wastewater is treated in a series of steps (as shown in Figure 1). The conventional sequence goes from pre-treatment to primary and secondary, and sometimes tertiary, treatment. The treated effluent is eventually discharged, usually to a nearby water resource. This section provides a basic overview of the process.

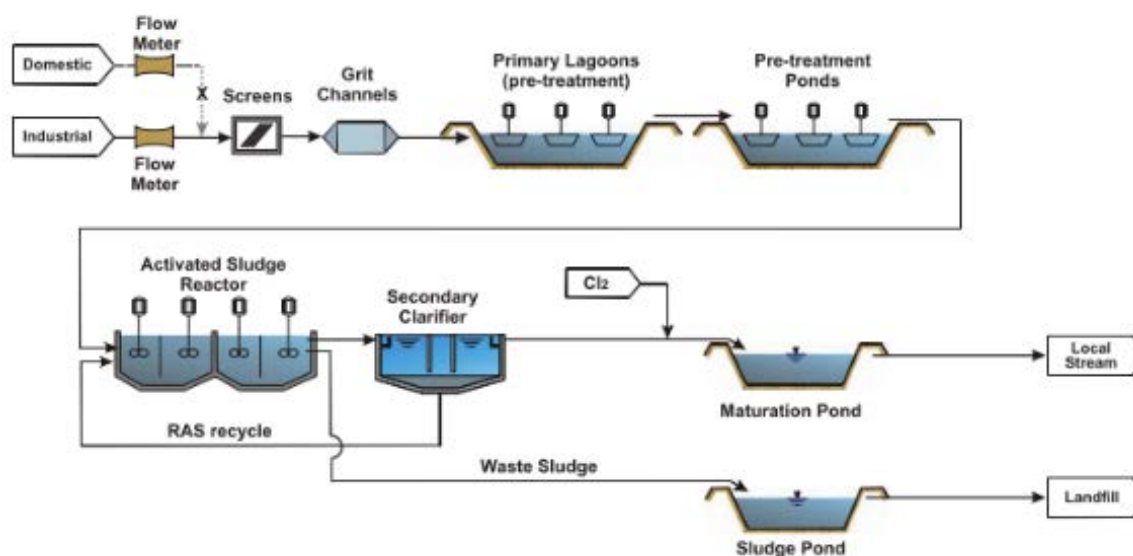

Figure 1: Schematic of an activated sludge wastewater treatment process (SOURCE: Boyd, pg 126)

2.2.1 Collection and transport

Sewage is collected and transported by a network of pipes and pump stations to a treatment plant. Typically, lateral sewer pipes in residential, commercial, and industrial buildings carry wastewater to the main sanitary sewer system, as shown in Figure 2. A different system of channels and pipes are usually designed to ensure storm water from roofs, parking lots, driveways, and streets drain directly into creeks, rivers, or basins. If storm water or groundwater find their way into the collection system, it can overload the sanitary sewer system, potentially resulting in sewer backups or overflows (City of Lee’s Summit, 2014). Van der Merwe-Botha and Manus (2011) state that the “under investment in sewer collection and sludge handling infrastructure” is a common problem (pg.1). (Dijk & Vuuren, 2011) describe the sewage collection and conveyance systems as “an extensive, valuable and complex part of the country’s infrastructure.”

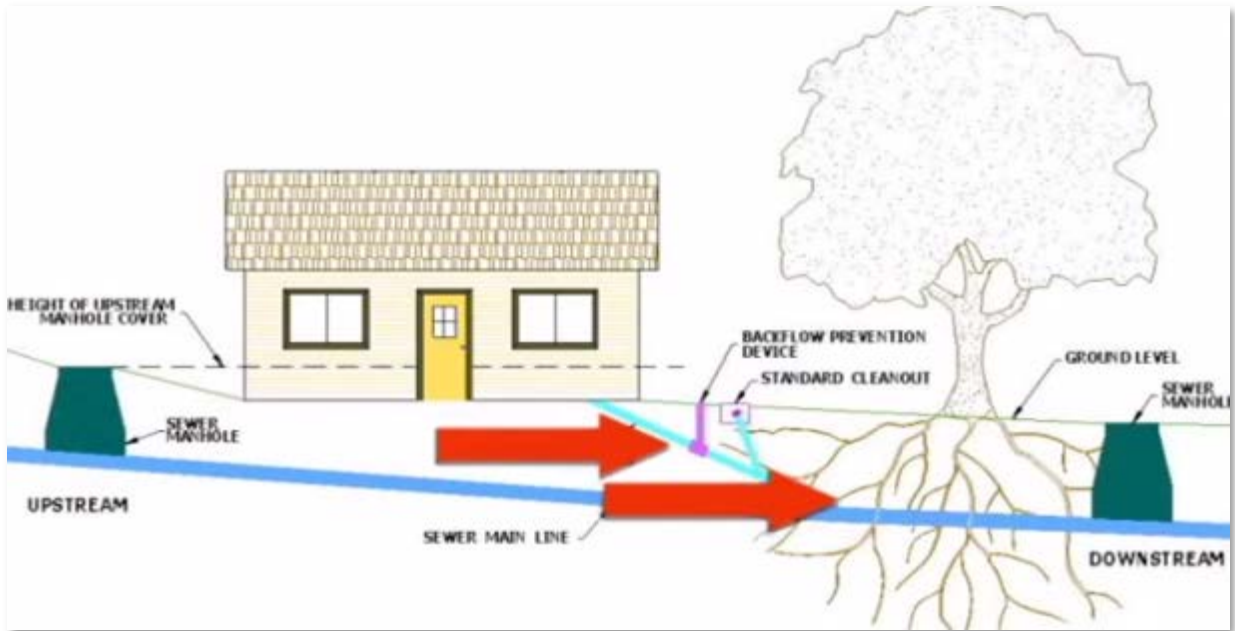

Figure 2: Initial WW flow (<https://www.youtube.com/watch?v=pRaptzcp9G4>)

Sewage flows, by gravity, towards the WWTW. If the mains become too deep (in flat areas), then the wastewater must be elevated by a pump at a lift station. After collecting in a wet well, the pump lifts the sewage to again allow gravity to carry the sewage, as shown in Figure 3. The pumps must function continuously; therefore, the maintenance of electrical equipment and motors, as well as back-up diesel generators to provide power in the event of electricity outages, is crucially important. (Dijk & Vuuren, 2011) point out that “the public expects these systems to function effectively at a reasonable cost.”

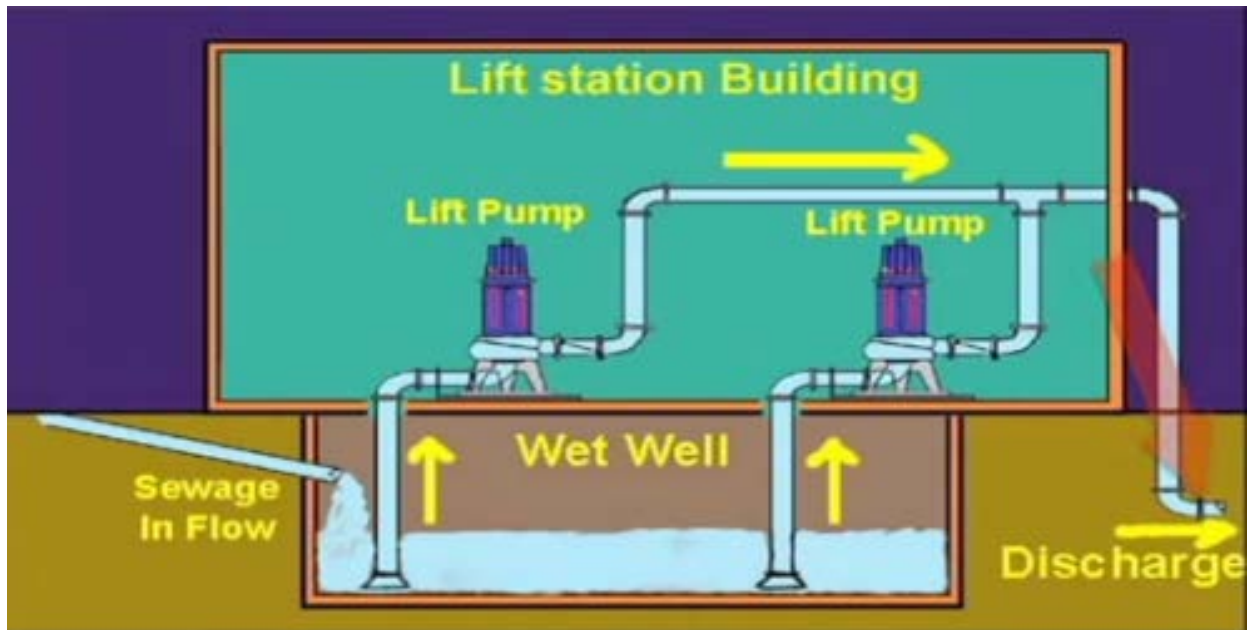

Figure 3: Lift station (<https://www.youtube.com/watch?v=pRaptzcp9G4>)

2.2.2 Pre-treatment or Preliminary treatment

When the sewage arrives at the WWTW, it is collected in a wet well. The purpose of this tank is to stabilise flow because an even flow rate is essential for plant operations. Changes in the volumes entering the wet wells, measured by flow meters, alert operators to possible problems upstream and the need for operational adjustments (Boyd, 12). From the wet well, pump stations pump raw sewage into the plant for preliminary treatment.

The first cleansing process, often called preliminary treatment, is designed to remove gross solids from the incoming wastewater with screens. As wastewater is pumped into the plant, it flows through a bar screen to filter out large debris, such as rubbish, diapers, sanitary products, stones, bricks, broken glass, logs, metal, and various other floatables. Finer screens and filters remove more waste. These materials can significantly interfere with treatment processes, by clogging or damaging the plant equipment, if not removed. The screens need to be cleaned regularly to prevent the build-up of debris (Boyd & Mbelu, 2009). Screens can be cleaned manually with a rake and wheelbarrow; automated screens are self-cleaning, but must be maintained. An example of bad screens are shown in Figure 4.

SCREENS: BAD

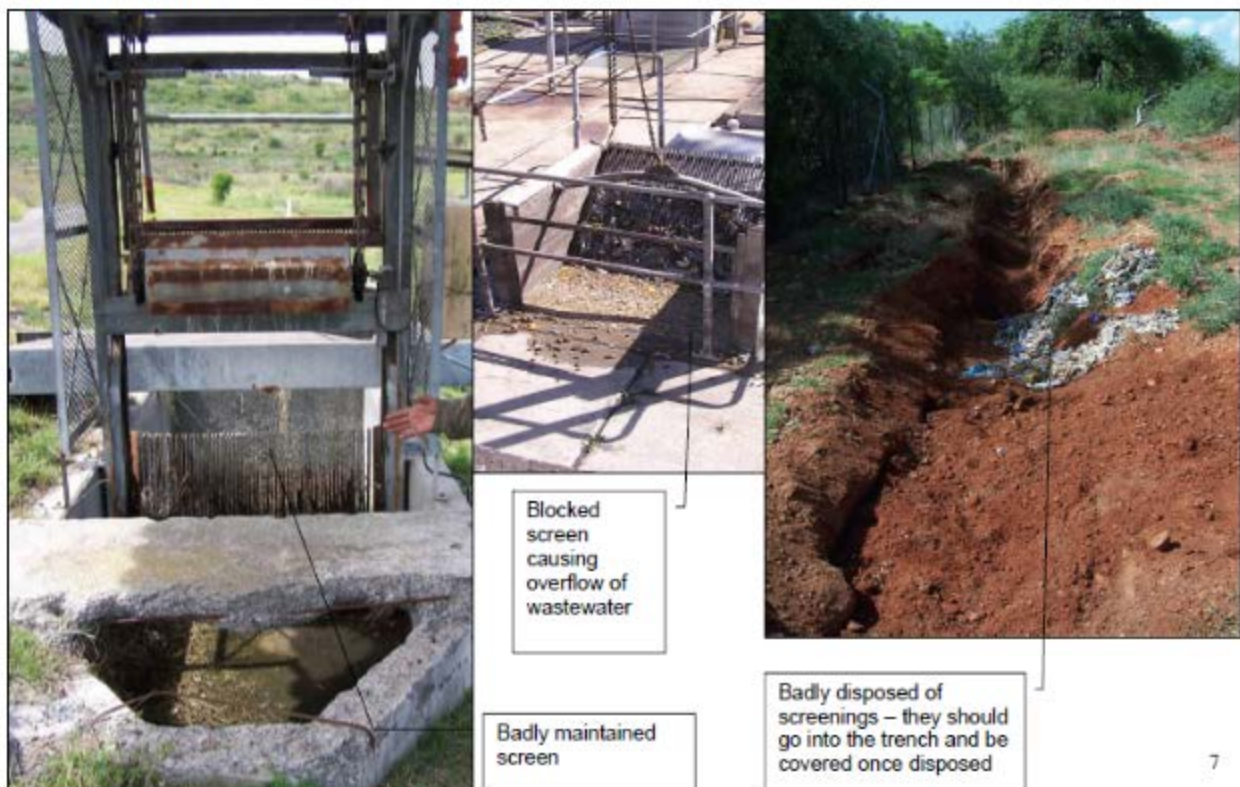

Figure 4: Bad screens (SOURCE: Boyd & Mbelu, 2009)

The trash separated from wastewater is meant to be dried, broken down, dumped into a bin, and hauled to a landfill. Boyd and Mbelu (2009) caution “the screened materials are hazardous and must be safely disposed of to prevent human health concerns, fly breeding and odours (pg. 4).”

In a similar function to screens, **grit channels** serve to remove sand, silt, glass, and other large-sized organic and inorganic substances from wastewater by lowering the velocity of water so the grit settles out. The degritter includes a cleaning scraper to remove settled grit from the channel; the slurry of grit is then pumped onto a conveyor to be discharged.



This is an important step in the treatment process because, like large debris, excess grit can block or break mechanical equipment. Lighter particles and organics pass through to primary treatment (Boyd and Mbelu, 2009).

2.2.3 Primary treatment

Primary treatment is the basic process to remove suspended solids (mainly organics) and fats, oils and grease from the wastewater. In typical large-capacity treatment plants, the wastewater goes to **primary clarifiers**, as shown in Figure 5, where fats, oils and grease float to the surface while heavy solids settle to the bottom.



Figure 5: Primary clarifier (<http://www.ci.camarillo.ca.us/i3.aspx?p=1047>)

On the surface, grease balls form (as shown in Figure 6) and other floating materials are removed by skimmers. Their removal is important because floating materials can cause damage by plugging pumps.



Figure 6: Grease balls forming in the wet well (<https://www.youtube.com/watch?v=pRaptzcp9G4>).

The flow of wastewater in primary clarifiers is slow, and sometimes chemicals such as aluminium are used, to accelerate sedimentation. A steel framework moves scrapers around the slopped bottom,

pushing solids towards the centre for removal. The sediment is known as primary sludge and is pumped off to be dewatered and taken to landfill. Primary treatment reduces BOD by 20-30 percent by removing about half of the suspended solids and nitrogen, but almost all of the phosphate remains.

2.2.4 Secondary treatment

The purpose of secondary treatment is to further remove organic matter and ammonia, which must be removed to protect drinking water and fish habitat. There are many types of secondary treatment technologies, including: the activated sludge process, bio-filters, and variants of pond and constructed wetland systems, which are described in more detail below. Figure 7 shows the number and sum capacity of types of secondary treatment processes used in WWTW in South Africa. In all secondary treatment technologies, biological processes break down organic matter and ammonia by mixing microorganisms with wastewater. The microorganisms consume and digest the organic matter, converting it to carbon dioxide, water, and energy for their own growth and reproduction. With the uptake of oxygen, ammonia (NH_3) breaks down to nitrates (NH_4NO_3) and nitrogen (N_2).

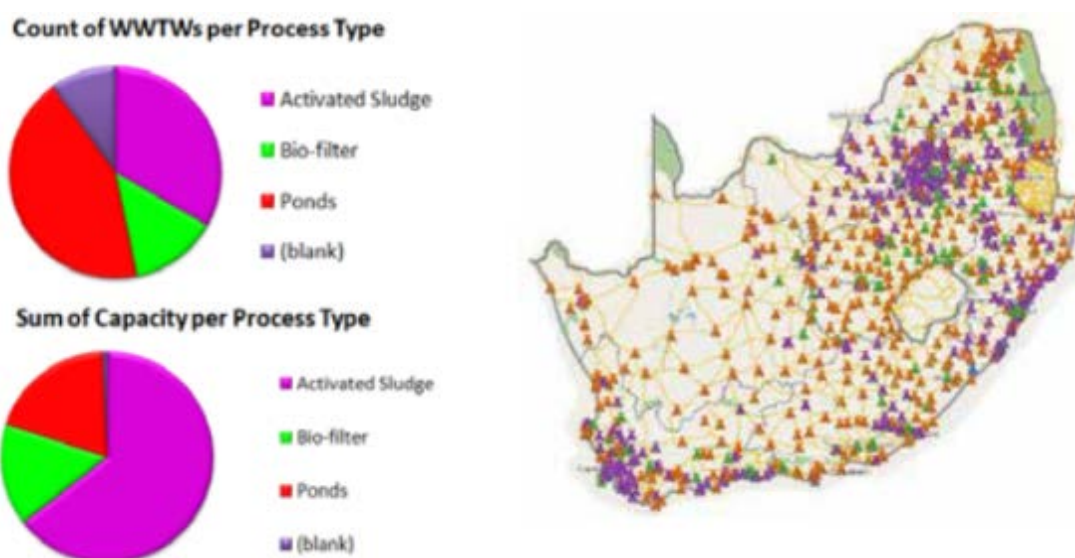

Figure 7: Types of secondary treatment in SA (SOURCE: Department of Water Affairs, 2013)

Activated Sludge

In the activated sludge process, effluent from the primary clarifier chamber water is pumped into an aeration basin (as shown in Figure 9). The first part of the aeration chamber is an anoxic zone, filled with microorganisms that thrive under less oxygen. The second part of the aeration chamber is an oxic zone, where diffusers break up the air to overdose the microorganisms with oxygen (as shown in Figure 9). It is important to bear in mind how long the wastewater stays in the aeration basin—a period known as the solids retention time (SRT)—as well as ensuring continuous electricity for the diffusers, with back-up generators in the case of power loss (LA Boyd & Mbelu, 2009).

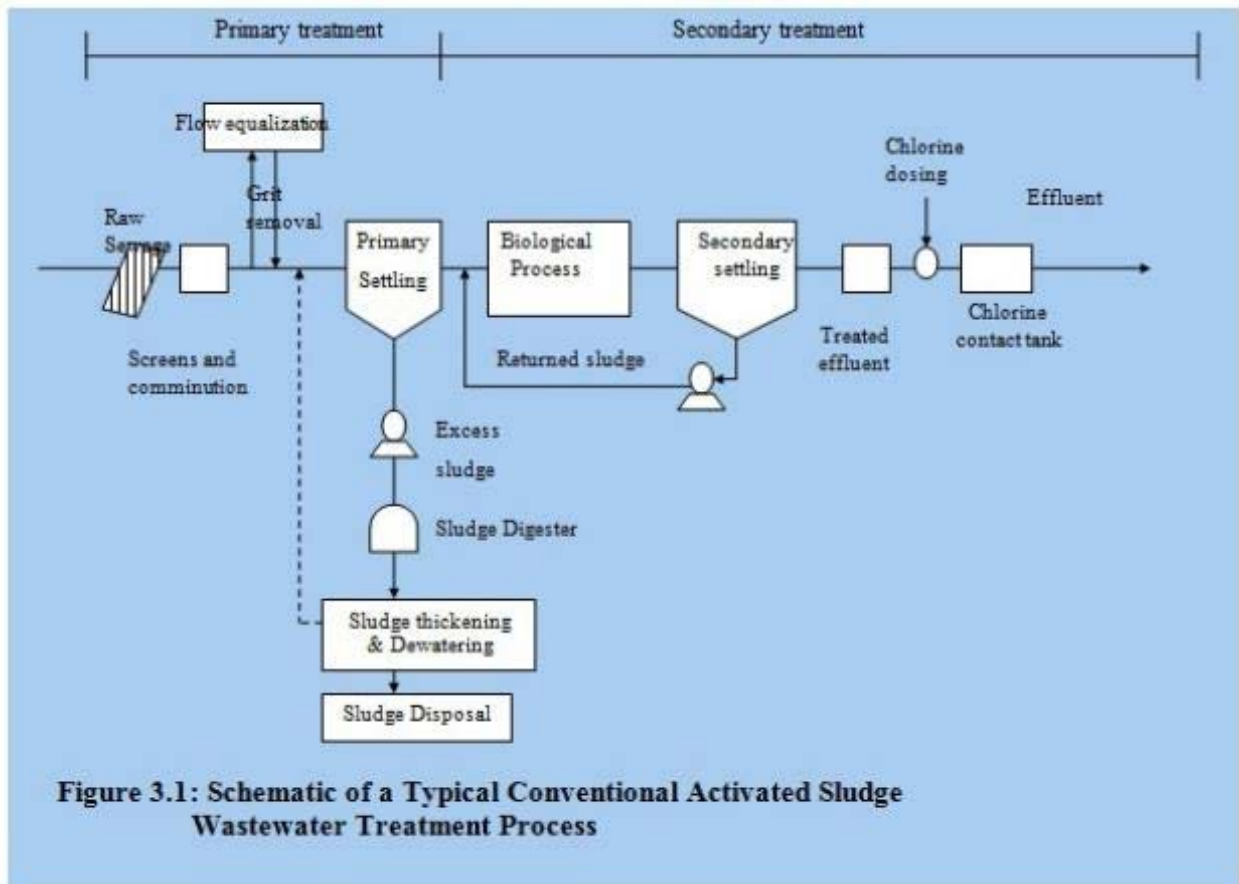

Figure 8: Schematic of a Typical Conventional Activated Sludge Wastewater Treatment Process



Figure 9: Anoxic and oxic zones of an aeration chamber
(SOURCE: <https://www.youtube.com/watch?v=pRaptzcp9G4>)

Bio-filter

Another common type of secondary treatment is a bio-filter (also known as trickling filters and rotating biological contactors), as shown in Figure 10. Boyd and Mbelu (2009) explain that these processes, “utilise microorganisms that grow on a medium, such as stones and discs, to remove organic matter found in wastewater. They can also be used to achieve nitrification - the conversion of ammonia to nitrate/nitrite (pg. 23).” Like all equipment for wastewater treatment, it is important to maintain the bio-filters. Figure 10 shows an example of poorly maintained rotating biological contactors.



Figure 10: Poorly maintained rotating biological contactors (SOURCE: Boyd & Mbelu, 2009)

The biological processes in both activated sludge and bio-filters are followed by additional settling tanks (sometimes referred to as **secondary sedimentation**) to remove more of the suspended solids; these final clarifiers act similarly to the primary clarifiers, serving to clarify the effluent before being discharged into a water resource (Boyd and Mbelu, 2009, pg. 35).

Ponds or constructed wetlands

Variations of ponds or constructed wetlands, as shown in Figure 11, are a third common type of secondary treatment. The effluent is purified as it flows through a bed of granular material, often with reeds consuming the nutrients and converting ammonia to nitrogen gas. Ponds effectively function to polish and disinfect. In addition to improving the quality of the final effluent, ponds and wetlands can also serve as a buffer in case of a breakdown at the wastewater treatment plant.

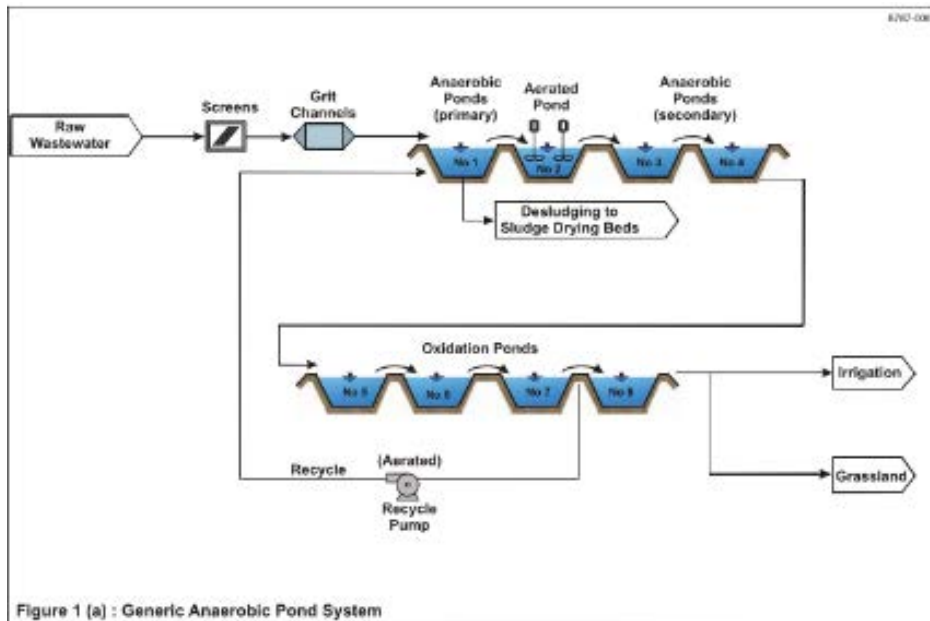

Figure 11: Schematic of generic anaerobic pond system process (SOURCE: Boyd and Mbelu (2009), pg. 121)

OXIDATION PONDS: BAD

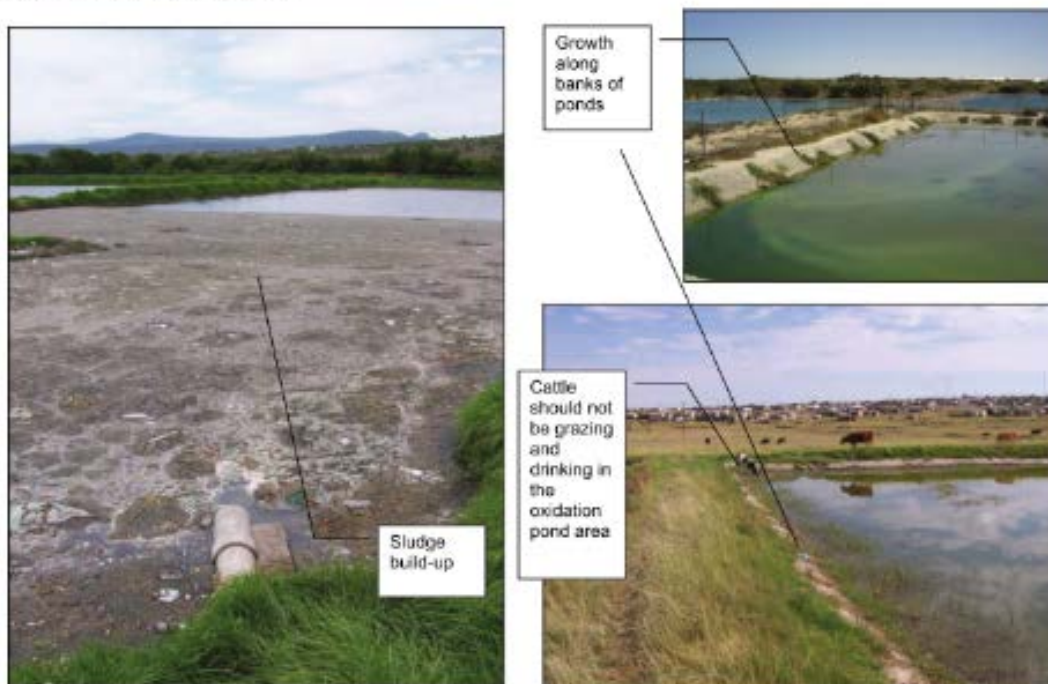

Figure 12: Photos of bad oxidation ponds (SOURCE: Boyd & Mbelu, 2009)

2.2.5 Tertiary treatment

Tertiary treatment is simply additional treatment beyond any previous steps to further remove contaminants or specific pollutants. Phosphorus and nitrogen removal and chemical disinfection are common types of tertiary treatment in South Africa. Tertiary treatment can remove almost all of the impurities from sewage, but is normally expensive.



Phosphorus and nitrogen removal

Tertiary treatment is often used to remove phosphorous or nitrogen, which cause eutrophication. Conventional secondary treatment processes are often modified to remove the loads. In some WWTWs, the effluent is dosed with chemicals to cause the phosphates to coagulate and clear. Boyd and Mbelu, (2009) list several chemicals that are effective for phosphates removal, including: ferric chloride, ferric sulphate, ferrous sulphates and alum.

Disinfection

Boyd and Mbelu (2009) explain the importance and process of disinfection: “While each unit process reduces the number of microorganisms, high numbers of pathogenic organisms will still remain even after the best possible biological treatment. The goal of disinfection therefore is to remove or inactivate pathogenic microorganisms [...]. The primary pathogenic micro-organisms targeted for inactivation include bacteria, viruses and protozoan cysts (pg. 39). For example, the effluent must meet standards for E. coli and fecal coliform. In some cases, operators add chemicals, typically chlorine, as a disinfectant. Boyd and Mbelu (2009) continue, stressing “it is therefore very important to have disinfection process/equipment in place and in working order (pg. 39).”

However, 67% of the plants that disinfect final effluent in South Africa are experiencing operational problems. Snyman, Van Niekerk, and Rajasakran (2008) say that, “problems include inadequate design of disinfection systems, inappropriate disinfection technology employed, inadequate operation and management of chlorine stock.” The World Bank Group (2014) reports “[d]isinfection is frequently built into treatment plant design, but not effectively practiced, because of the high cost of chlorine.”

In addition, as the Department of Water Affairs (2010) points out in the Wastewater Risk Abatement Plan Guidelines, disinfection “requires careful process control of the disinfection species, dosage and contact time (pg 60).”

2.2.6 Discharge

After the final treatment, the effluent is discharged. The expected quality of the discharge is often determined by the intended use of the effluent, i.e. will the effluent be discharged to a water course, agricultural or industrial use (van der Merwe-Botha & Manus, 2011)? The effluent usually flows through a pipe or canal into a stream, river, or wetland. A weir is often installed to maintain constant flow of water. Nozaic and Freese (2009) explain that discharge into a water resource must be authorised and operators, “must submit a registration form or any other information requested in writing by the responsible authority for registration of the water use before commencement of the discharge (pg. 33).” Figure 13 shows an example of bad final effluent.



Poor discharge of final effluent – discharge point should not be submerged. Final effluent should preferably cascade to allow final aeration before entering water resource.

Figure 13: Bad final effluent (SOURCE: Boyd and Mbelu, pg 51).

2.3 Managing Wastewater Treatment Works

2.3.1 Planning

Municipal planners design, plan and build new infrastructure and upgrades to WWTW. When selecting the appropriate number and capacity of pumps, pipes, channels, tanks and equipment for treatment and disposal, both the quantity and quality of the receiving and final effluent should be taken into account. The typical inflow is affected by the catchment area and number of industrial and domestic sources. It is usually measured and reported as Average Dry Weather Flow and Peak Wet Weather Flow, as shown in Figure 14. The receiving effluent quality is determined by the source of effluent. Van der Merwe-Botha and Manus (2011) note that “there is limited control over the quantity and quality of the raw wastewater [... and that] variations in the parameters of the received untreated wastewater (quantity and quality) can be significant, due to influences of the waste generating sources and allowance must be made for this (pg 16).”

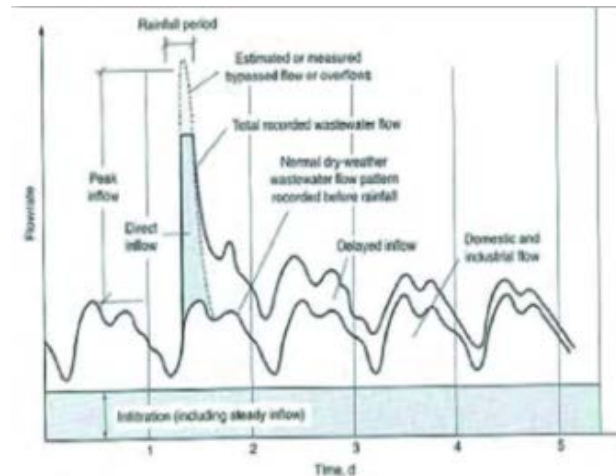

Figure 14: Graphic identification of inflow (SOURCE: Metcalf & Eddy, 2005 in van der Merwe-Botha, 2011, pg 76)

The required final treated effluent quality is typically set by a number of water quality objectives of the receiving water resource and restrictions on effluent quality limits within the catchment, which are described in Section 3 below.

Several challenges with planning are identified in the literature. Many challenges centre on plant wastewater flow and loads. Snyman et al. (2008) present the following figures:

- 16% of WWTWs in South Africa are hydraulically overloaded.
- 22% of WWTWs in South Africa are overloaded in terms of the organic/nutrient load.
- Less than 35 % of the plants can accommodate higher flows and loads.

In addition, van der Merwe-Botha and Manus (2011) note that it is difficult to meet the demand of rapidly increasing housing developments.

2.3.2 Operating

In typical municipalities in South Africa, there is a Water and Sanitation Officer or Technical Officer in the municipality. Depending on the size and number of the WWTWs in the Local Municipality, there is also often a superintendent for several plants and then supervisor for each (or a couple) plants. The supervisor oversees day to day operations. The plant is operated by Process Controllers (PCs) and assistants. Operators are meant to have sufficient training to operate the plant (described as a certain Class). Table 2 shows typical operational practices associated with each step of the wastewater treatment process.



TABLE 2: OPERATIONAL PRACTICES ASSOCIATED WITH STEPS OF THE WASTEWATER TREATMENT PROCESS.

TREATMENT PROCESS	ASSOCIATED OPERATIONAL TASK
COLLECTION AND TRANSPORT	<ul style="list-style-type: none"> ■ Ensure pumps are in working order ■ Routine maintenance ■ Address blockages and leaks ■ Prepare for power outages and breakages (i.e. have some pumps on standby)
PRE-TREATMENT	<ul style="list-style-type: none"> ■ Monitor and clean screens ■ Open and close channels
PRIMARY TREATMENT	<ul style="list-style-type: none"> ■ Understand the capacity of the WWTW and how to accommodate overflow ■ Monitor the retention time
SECONDARY TREATMENT	<ul style="list-style-type: none"> ■ Manage the biochemical processes
TERTIARY TREATMENT	<ul style="list-style-type: none"> ■ Purchase chemicals ■ Dose the right amount of chemicals at the correct frequency
DISCHARGE	<ul style="list-style-type: none"> ■ Effluent management

Bender and Gibson (2010) note: “The key to success lies in three areas: attracting and retaining quality people who have the skills, expertise and customer focus, as well as supporting resources, to optimize the service delivery; ensuring that sufficient funds (both capital and operating) are available to pay for the skills and to expand and maintain the required infrastructure; a strong contract management control that ensures contract compliance and enforces the requirements of the authority within the terms of the contract (pg. 9)(Bender & Gibson, 2010).”

The literature lists several challenges with operating WWTWs; the most commonly cited challenge is the shortage of skills. Van der Merwe-Botha and Manus (2011) say there is generally a “low skills base to manage, operate and maintain the specialised nature of wastewater services (pg. 1).” Brown (2001) says the consequence is that “most I-S wastewater treatment works do not achieve the design removal of pollutants due to lack of operational and maintenance knowledge. The operator should, in many cases, be able to provide better effluent at a lower cost through improved knowledge, especially in preventive maintenance (pg. 2).”

“The most pressing need is the critical shortage of trained, skilled and experienced process controllers and mechanical/electrical maintenance staff.”

Snyman et al. (2008), pg. 2



Snyman et al. (2008) document that “additional skilled operational staff is required to operate the plant efficiently at 50% of the plants” and provide the following national figures:

- Major intervention required and practically no trained and competent operations staff available to plant (10%);
- Intervention required with a limited number of trained and competent operations staff available to plant (40%);
- Plant adequately resourced in terms of operations staff but further training of staff required (36%);
- Staff properly trained, qualified and experienced to competently operate the treatment plant. Ongoing training and education programmes are implemented (4%); and
- Plant facility has more trained and qualified operational staff allocated to the entire operation of the plant than is required (10%).

TABLE 3: ESTIMATED NUMBER OF PROCESS CONTROLLERS REQUIRED TO EFFECTIVELY OPERATE THE MICRO, SMALL AND MEDIUM WASTEWATER TREATMENT PLANTS IN SOUTH AFRICA
(SOURCE: (SNYMAN ET AL., 2008))

Class operator	Number of operators required	Number of registered operators in the DWAF data base	Shortfall of registered operators
Trainee	838	438	400
I	1136	71	1065
II	838	153	685
III	696	229	467
IV	298	254	44
V	76	438 (76)*	- 362 (0)*
TOTAL	3882	1583	2299
TOTAL (Correction for Class V)*	3882	1221	2661

In addition to skills and staffing shortages, securing sufficient funds and enforcing requirements are challenging aspects of operating WWTWs.

2.3.3 Monitoring

Van der Merwe-Botha explains that “operational monitoring of control measures allows the system operator to assess, in a timeous manner, the effectiveness of the management and the performance of the system and under take the necessary remedial action if and when required (pg. 70).” Please see the sections on effluent discharge standards and monitoring below for a longer explanation of what is monitored.

Monitoring is often carried out by the Process Controllers. Boyd and Mbelu (2009) explain that “The Process Manager must understand the contents of the authorisation relevant to the WWTW. If an authorisation is not in place, the person ultimately responsible for municipal services such as wastewater treatment (e.g. the Town Engineer, Municipal Manager, etc.) or his/her representative in that department, must liaise with the relevant authorities to get it in place and ensure that the Process Manager understands the legal requirements and the need to comply (pg. 81).”



The process steps involved in monitoring include:

1. Determine what should be monitored and how often.

All authorisations, such as water use licence, general authorisation, or previous exemptions (general/special standard), contain conditions which stipulate the parameters to be measured and the frequency of monitoring. In general, WWTWs monitor:

- Chemical Oxygen Demand (COD);
- Dissolved oxygen;
- Total dissolved solids;
- Nitrate;
- Suspended solids;
- Ortho-phosphate;
- Ammonia;
- pH;
- Suspended Solids (SS); and
- Total and Volatile Solids (TS and VS).
-

2. Establish a monitoring programme.

This step should detail the strategies to follow for monitoring the wastewater treatment system. Van der Merwe-Botha and Manus (2011, pg. 95) suggest the following should be considered:

- parameters to be monitored;
- sampling or assessment location and frequency;
- sampling or assessment methods and equipment;
- schedules and frequency for sampling or assessment;
- methods for quality assurance and validation of results;
- requirements for checking and interpreting results;
- responsibilities and necessary qualifications of staff;
- requirements for documentation and management of records, including how monitoring results will be recorded and stored; and
- requirements for reporting and communication of results.

3. Sample.

Samples to indicate the quality of the water should be taken upstream, in the plant, at the point of discharge, and downstream. “Samples of the water containing waste must be taken as prescribed, and in accordance with the applicable South African National Standard (SANS) for sampling (Revision of General Authorisations in terms of Section 39 of the National Water Act, 1998).” Boyd emphasises the importance of regular monitoring, saying “In order to get an understanding of the effluent quality, it is important to take final effluent samples daily and to record the results to get a trend. Sampling on a frequency less than this would render the overall interpretation of the results meaningless (pg. 48).”

4. Analyse the results.

Some WWTWs have a laboratory on site. It is important that the Process Controllers follow standard methods of analysis. Other WWTWs do not have the capacity to analyse the results on site and send their samples off-site. If samples are sent away, there needs to be an agreement with the lab for results to be transferred telephonically. The samples are meant to be analysed in accredited laboratories. However, it is often hard to get samples to accredited laboratories. Van der Merwe-Botha and Manus (2011) explain that other than the availability of appropriate analytical facilities, other issues include “the cost of analyses, the possible deterioration of samples, the stability of the contaminant, the likely occurrence of the contaminant in various supplies, the most suitable point for monitoring and the frequency of sampling (pg. 84).”

5. Make operational adjustment.

Boyd stresses that “The Process Manager must ensure that he/she receives the results of the analyses within as short a time as possible to be able to interpret the results and make operational adjustments as required (Boyd, 72).” Van der Merwe-Botha and Manus (2011) contribute further, saying “A control measure is triggered whenever monitoring or reporting indicates that critical limits have been exceeded at any point along the wastewater services value chain (pg. 27).”

6. Keep records and disclose information

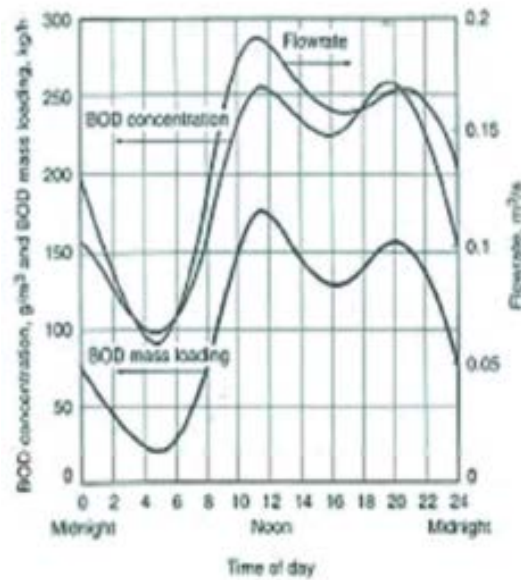

Figure 15: Illustration of diurnal wastewater flow, BOD, and mass loading variability.
(SOURCE: Metcalf & Eddy, 2005 in van der Merwe-Botha, 2011, pg 76)

Neil Griffin (pers. comm., 2014) explained that in addition to individual WWTW monitoring, DWS monitors watercourses at a regional level. A technician is sent out to the monitoring sights; the monitoring sights were selected a long time ago on important rivers. The Apartheid homelands didn't have much monitoring. These samples are sent to an RQS labs and analysed. The results go into wRMS database.

2.3.4 Maintaining

Municipalities usually have a maintenance team consisting of at least the following staff and support:

- electrician;
- fitter and turner;
- instrumentation technician;
- mode of transport; and
- tool kits and basic spare parts.

This practice is very important because “wastewater collection and treatment systems operate 24 hours, 7 days, 365 days of the year. The environment in which these municipal assets operate is aggressive, corrosive and subject to aging infrastructure (van der Merwe-Botha & Manus, 2011).



There are generally three types of maintenance activities:

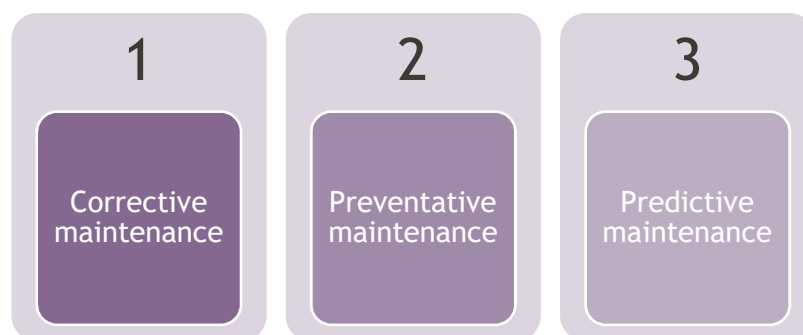

Corrective maintenance is important to address issues of immediate concern, such as a burst. *Boyd and Mbelu (2009) provide very useful explanations in their Guideline for the Inspection of Wastewater Treatment Works: “Maintenance personnel (including electricians and fitters) need to be available at all times. [...]The maintenance personnel need to be able to respond within a reasonable timeframe (the time taken to respond must be such that the breakdown does not severely affect the final effluent quality). (pg. 78).”* They continue “[a]t the smaller and more rural WWTWs it is expected that technical expertise will be limited. In this respect it is important that a technical expert is available to be contacted for advice on troubleshooting as necessary (pg. 79).” Boyd and Mbelu say “Standby equipment such as pumps and motors should be kept on site so that when a pump/motor needs maintenance, the standby can be put in place and the operation of the works will not be disrupted. It is imperative to ensure that standby equipment is available and in working order (pg. 67).” Boyd and Mbelu also stress that “It is important to keep a record of all malfunctions or mechanical equipment that is broken, the date when they were reported and when the repair was done (pg. 67).”

Boyd and Mbelu also provide useful guidance on preventative maintenance: “A planned maintenance schedule is essential to ensure that mechanical equipment is always in working order. A schedule needs to be drawn up and implemented by the Process Manager (pg. 66).” Brown (2001) stresses that “*the operator should, in many cases, be able to provide better effluent at a lower cost through improved knowledge, especially in preventive maintenance (pg. 2).*” Boyd and Mbelu continue, urging that “Records should be kept of preventative maintenance procedures including: Lubrication schedules, spare parts (required and available), stoppages and malfunctions (pg. 17).” Figure 16 and Figure 17 show examples of good and bad maintenance, respectively.

Predictive maintenance entails asset management, explained in the sub-section below.

MAINTENANCE: GOOD



68

Figure 16: Example of good maintenance (SOURCE: Boyd and Mbelu (2009), pg. 68)

MAINTENANCE: BAD



Figure 17: Example of bad maintenance (SOURCE: Boyd and Mbelu (2009), pg. 69)



Boyd and Mbelu suggest the use of checklists, like that shown in Figure 18, to aid in maintenance.

	UNIT PROCESS		✓	Number
PRELIMINARY TREATMENT PROCESSES	Screens	manual		
		mechanical		
	Grit removal	manually cleaned channels		
		mechanically cleaned channels		
		automated de-gritters		
	Flow measuring device			
Flow balancing/equalization basin/tank				
PRIMARY TREATMENT PROCESSES	Primary settling			
	Oxidation pond system			
	Flow balancing/equalization basin/tank			
SECONDARY TREATMENT PROCESSES	Trickling filters			
	Activated sludge			
	Rotating biological contactors			
	Secondary settler	humus tank		
		clarifier		
TERTIARY TREATMENT PROCESSES	Disinfection (e.g. chemical, UV)			
	Constructed wetlands			
	Maturation pond/s			
SLUDGE TREATMENT PROCESSES	Dewatering	filter/belt press		
		drying beds		
		gravity		
	Thickening	dissolved air flotation		
		Digestion		

Figure 18: Example of a checklist SOURCE: (Boyd and Mbelu (2009), pg. 86).

Asset management plans

According to the DWS, “In order to ensure long term effective water services delivery, an Asset Management process must be followed when buying or creating an asset, and when maintaining, replacing and disposing of assets in a cost effective manner.” This process is depicted in Figure 19.

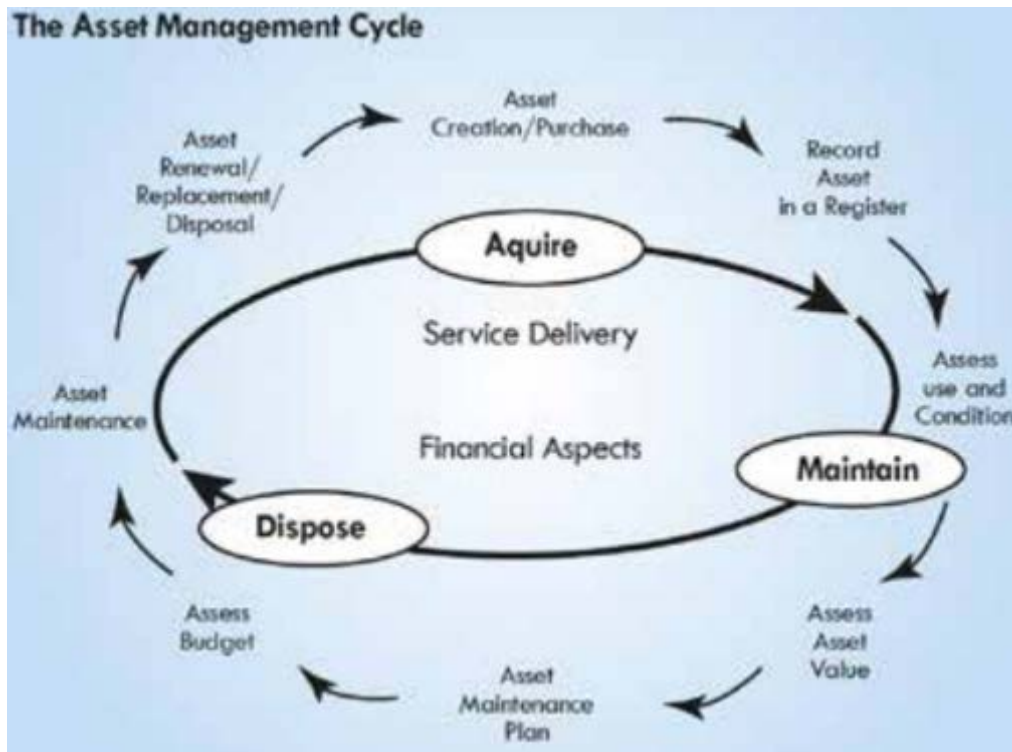

Figure 19: The Asset Management Cycle SOURCE: (Department of Water Affairs, 2013)

The Water Services Act requires every Water Service Authority to have an Asset Management Plan. “WSAs must protect their assets by ensuring that an appropriate maintenance and rehabilitation plan is developed and implemented. Unfortunately a number of WSAs do not budget sufficiently for asset maintenance and replacement. Expensive refurbishment becomes necessary and then there is less money for ongoing maintenance. Deteriorating infrastructure also leads to poor service delivery and reduced levels of payment by consumers due to dissatisfaction, exacerbating lack of cost recovery.”

Maintenance challenges

In addition to general challenges with asset management plans, there is a general lack of maintenance, aging infrastructure, and inadequately skilled maintenance staff to adequately maintain the installed mechanical/electrical equipment and instrumentation at 56 % of the plants (Snyman et al., 2008). These problems are widespread: Figure 20 shows the percentage of WWTW in South Africa with problems with maintenance.

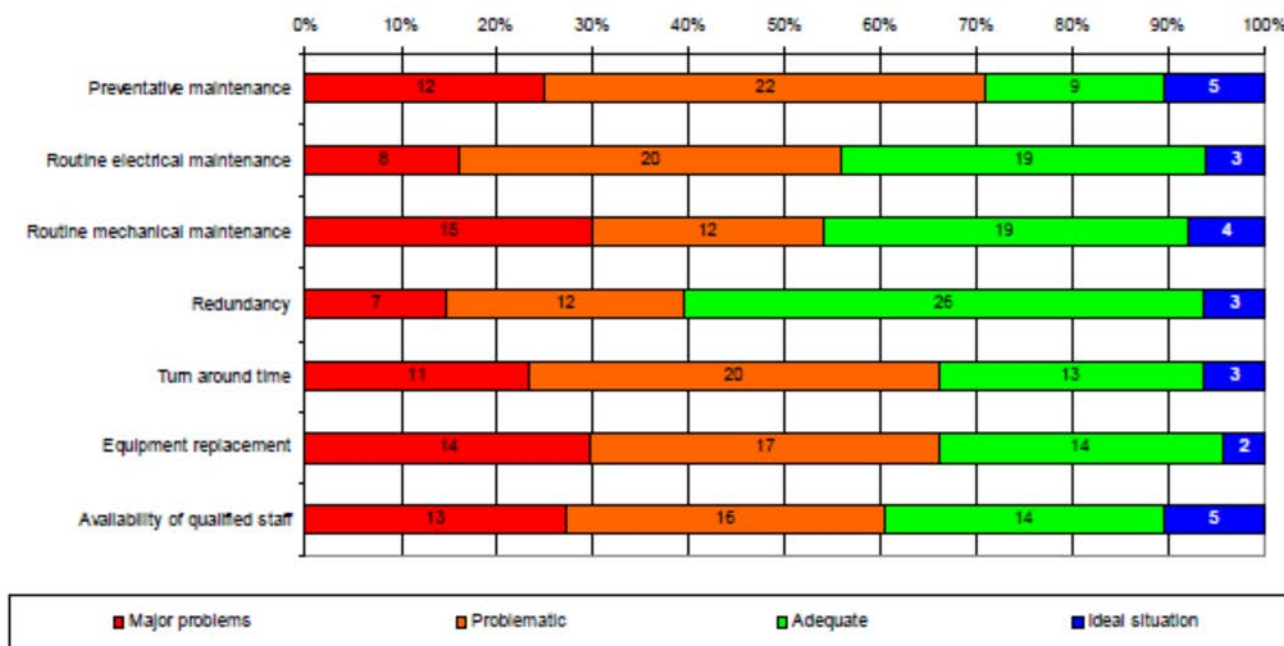

Figure 20: Percentage of WWTW in SA with problems with maintenance (SOURCE: (Snyman et al., 2008))

2.3.5 Risk abatement and disaster management

The Department of Water Affairs (2010) has started placing increasing emphasis on risk abatement and disaster management, stating in the Wastewater Risk Abatement Plan (WRAP) Guidelines that *“Incidents such as power outages, theft and vandalism, sludge lagoon walls rupturing, overtopping of ponds, mechanical/electrical/process control breakdown and discharge of substandard or untreated sewage to the environment have highlighted that managing risk is an integral part of the overall management of the municipal wastewater business [...] The most effective means of consistently ensuring the responsible treatment and discharge or reuse of wastewater and its byproducts, is through the use of a comprehensive risk assessment and risk management approach that encompasses all steps in the wastewater value chain, from production to discharge or reuse in a particular catchment (pg. 1).”*

At the national level, the main tool for risk abatement is the Waste Water Risk Abatement Plan (W2RAP) as part of Waste Water Risk Abatement Regulation Initiative. Van der Merwe-Botha and Manus (2011) explain that the purpose of the Wastewater Risk Abatement Plan is to identify *“control measures in a wastewater treatment system that will collectively control identified risks and ensure that the health-based and environmental targets are met. [...]”*

The process equips water management professionals to define control points and risk management procedures for the operation and maintenance of wastewater treatment plants. It aims to organise and coordinate effort of the responsible municipal units to achieve an impact on the ground (i.e. a clear turnaround] [...] Simply stated risk management plans address the question *“What (the event/incident) could go wrong (the Risk) the probability (the likelihood) that will it occur, what are the results (the consequences) of the incident, what do we have in place to prevent ‘the incident’ from occurring (contingency measures or risk control strategy), and if the event/incident does happen, how do we deal with it (emergency procedures)’ (pg. 2).”*

The general WRAP process, as described by van der Merwe-Botha and Manus (2011), includes the following steps:

1. **Conduct a system assessment** (including upgrade and improvement)
2. **Write management plans** which describe “actions to be taken during normal operation or incident conditions and documenting.”
3. **Identify control measures**, which “should reflect the likelihood and consequences of loss of control.”
4. **Monitor**: “For each control measure identified, an appropriate means of operational monitoring should be defined that will ensure that any deviation from required performance is rapidly detected in a timely manner.”
5. **Devise communication plan**
6. **Respond**: A “corrective action implemented in response to deviation from limits (pg 71-72).”
E.g Maintenance teams respond to pipe bursts, spills, leaks and declining water and effluent quality etc.

2.3.6 Financing

Figure 21 shows the basic financing structure of WWTWs: capital grants, such as the Municipal Infrastructure Grant (MIG), fund the infrastructure and operating grants and user charges are used to fund operations.

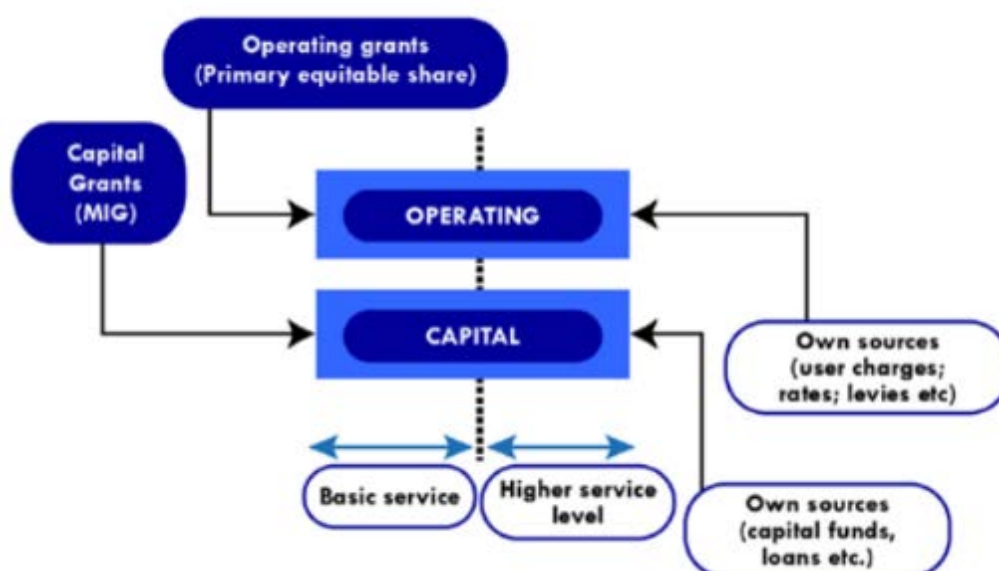

Figure 21: Municipal Grant Funding (DWS - Strategic Overview of the Water Sector, pg 55).

Financing infrastructure

The infrastructure for WWTWs is largely funded by the Municipal Infrastructure Grant (MIG), with funds released by National Treasury and distributed by the Department for Cooperative Governance and Traditional Authorities (COGTA), or the Regional Bulk Infrastructure Grant, with funds released by National Treasury and distributed by DWS. Table 4: The MIG allocation for water and sanitation (R billion) (SOURCE: DWS, pg. 56) province.



TABLE 4: THE MIG ALLOCATION FOR WATER AND SANITATION (R BILLION) (SOURCE: DWS, PG. 56)

Province	2012/13	2013/14	2014/15
Eastern Cape	1.75	1.84	1.98
Free State	0.44	0.46	0.50
Gauteng	0.16	0.17	0.18
KwaZulu-Natal	1.87	1.98	2.12
Limpopo	1.54	1.63	1.75
Mpumalanga	0.82	0.87	0.93
North West	0.76	0.81	0.87
Northern Cape	0.25	0.27	0.29
Western Cape	0.18	0.19	0.20
National Total	7.77	8.20	8.82

Others funding mechanisms include the Regional Bulk Infrastructure Grant (RBIG) and Municipal Water Infrastructure Grant (MWIG). Tyers and Mbatha (2010) explain that “the MIG is sometimes inadequate to allow for extending and upgrading services where there is insufficient bulk water or wastewater treatment capacity available - dedicated regional infrastructure funding is required for this (pg 48).”

In a national survey, DWS found that despite MWIG and RBIG funding, capital infrastructure investment is required at 35% of the plants.

Financing operations and maintenance

O&M is generally funded through user charges and the equitable share grant. Establishing a baseline cost for operations is an important step, and DWS and National Treasury are currently promoting this within municipalities (e.g. the baseline costing reported in Municipal Wastewater Treatment: First Order Costing Of Capital And Additional Operations And Maintenance Funding Requirements Based On Risk Based Indices (DWA, 2009) referenced in Scheepers and van der Merwe-Botha (2013).”

In most municipalities, revenue collection does not cover the costs of operations and they turn to an unconditional grant called the Equitable Share, which is provided to all municipalities to assist with operation and maintenance requirements and free basic services provision shows the Equitable Share allocation for water and sanitation per province.



TABLE 5: EQUITABLE SHARE FOR WATER AND SANITATION (R BILLION) PER PROVINCE (SOURCE: DWS)

Equitable Share for water and sanitation (R billion)			
Province	2012/13	2013/14	2014/15
Eastern Cape	46.94	49.60	52.22
Free State	18.53	19.47	20.41
Gauteng	54.55	58.61	62.88
KwaZulu-Natal	67.80	72.58	77.55
Limpopo	38.72	40.97	43.17
Mpumalanga	24.87	26.29	27.70
North West	8.26	8.74	9.23
Northern Cape	20.61	21.91	23.21
Western Cape	28.77	30.75	32.98
National Total	309.05	328.92	349.35

Boyd and Mbelu (2009) stress that “financial provisions must be made to ensure adequate stock and human resources requirements so that the WWTW can operate optimally. Chemicals, safety equipment and issues such as training of personnel are essential to the optimum working of a WWTW and finances must be available [...]The person ultimately responsible for municipal services such as wastewater treatment (e.g. the Town Engineer, Municipal Manager, etc) or his/her representative in that department, needs to understand the consequences of inadequate funding (for chemicals, training). The Process Controller in charge of the WWTW needs to highlight these issues to his/her line manager who must make provision (Boyd, 80).”

Issues of financial ring-fencing and other funding challenges are frequently mentioned in the literature. While Scheepers and van der Merwe-Botha (2013) note that “financial ring-fencing of water services provision is a legal requirement (Water Services Act of 1997)” they argue that “[d]efinitive information as to the extent of ring fencing is not readily available, although the Green Drop initiative is focusing more attention on this compliance parameter.” Another commonly cited challenge, as expressed by Tyers and Mbatha (2010), is that “the cost of sanitation service provision can vary drastically from area to area yet current MIG and equitable share formulas ignore this - higher funding is required for areas with challenging terrain or absence of local water sources (pg. 63).” The need for more funding is a commonly mentioned challenge. Figure 22 shows intervention is required for capital infrastructure, operations, and maintenance in over 30% of the plants included in the national DWS survey. However, as Snyman and others (2008) say, “*the need for additional or upgraded plant infrastructure or the need for additional funding is not the root cause of the poor performance at the majority of surveyed plants (pg. 10).*”

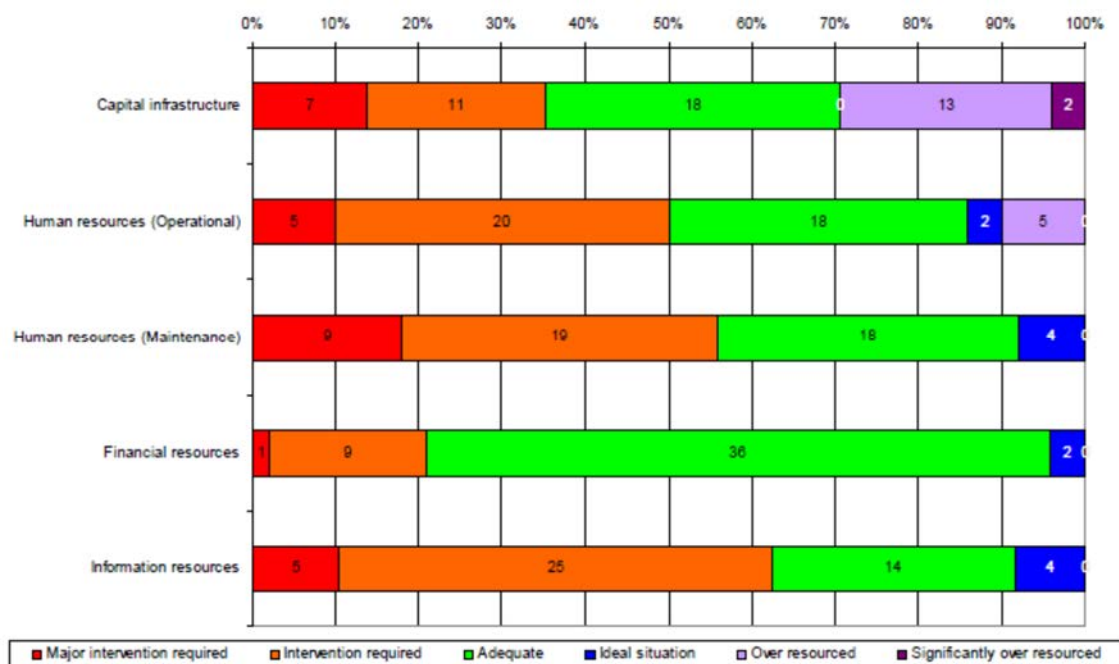

Figure 22: Resources deployed on wastewater treatment plans (SOURCE: (Snyman et al., 2008),

3 Wastewater Governance in South Africa

3.1 How WWTW fits into Water Resource Management in South Africa

WWTWs play a role in water resource protection and use. The aim of WWTWs is to treat the wastewater generated by residential, industrial, and commercial users to secure an environment not harmful to human or ecological health. The sewage may leak or spill and affect the water resource. Wastewater is treated at the WWTWs and then returned to a receiving resource. Mitchell et al. (2014) thus underscore how WWTWs are thus intertwined in natural resource protection, stating that *“the importance of well-functioning wastewater treatment works (WWTWs) is embedded within the fact that they are the last barrier and final interface between untreated/polluted/used water and a healthy and functioning ecosystem, and the health of the population.”*

Specifically, wastewater treatment affects water quality. Eales (2011) describes how:

- “Return flows and effluent streams add nutrients, bacteriological agents and salts which affect water quality and ecosystem services
- The poor quality of discharged effluent is contributing to rising eutrophication and bacteriological contamination of rivers and dams.
- Sewer seepage, spills, and contaminated effluent from wastewater treatment failures have severe consequences for ecosystem health”
- ‘Clean’ water is needed to dilute contaminated return-flows and mitigate the effects of rising salinity and nutrient levels for agricultural and industrial users, and rising pollution levels mean increasing volumes of clean raw water must be diverted for blending, which adds to water stresses (Eales, 2011, pg. 78).”

WWTWs are also seen as an integral part of service provision. “Water Services is a non- stop delivery process “from source to tap” and “from tap to source”. It requires the natural resource (water), processing (treatment works), distribution infrastructure and effective operation to deliver the actual output (potable water & safe sanitation) and its ultimate outcome (healthy people) (Department of Water Affairs, 2013, pg. 13).” The SIP 19 proposal depicted the role of sewage treatment in water services, as shown in Figure 23.

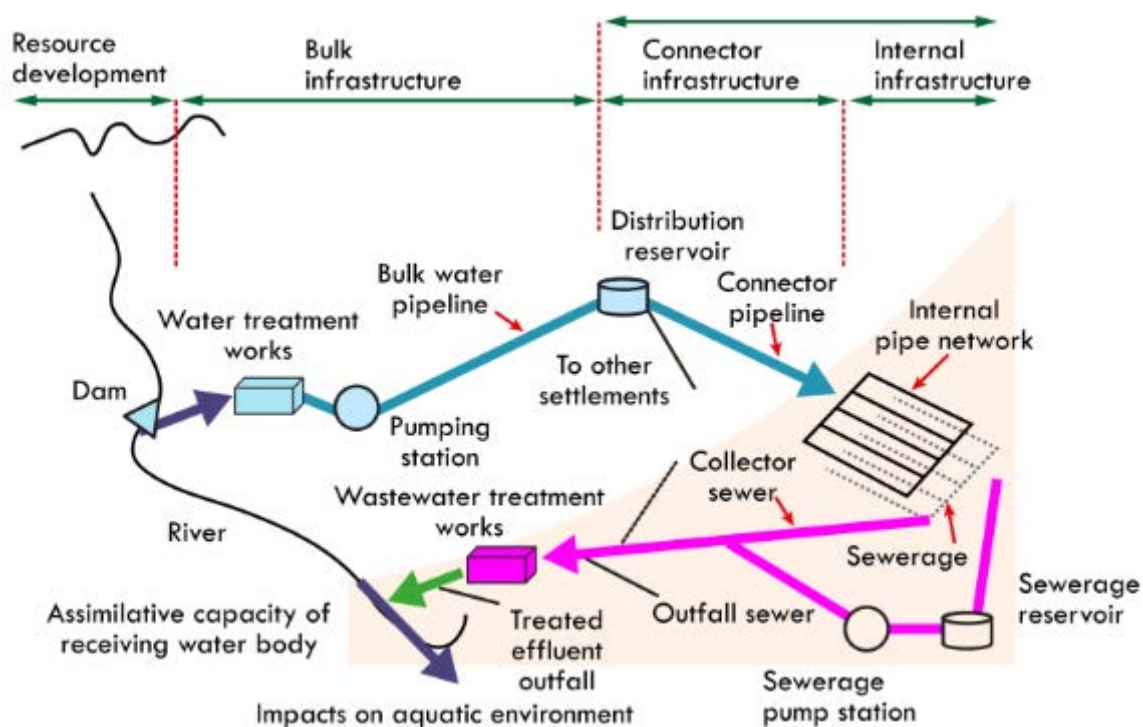

Figure 23: Water services lifecycle (Department of Water Affairs, 2013, pg. 13)

3.2 History

Both Mitchell et al. (2014) and Kidd (2011) provide useful historical information on WWTWs in South Africa. Their points are summarized and quoted below in chronological order:

- “Historically, provision of water services infrastructure was prioritised for the minority white population and their residential (and business) areas, whereas the black residential areas were not adequately serviced. This state of affairs was certainly perpetuated by the post-1948 apartheid government, but it had its roots far earlier (Kidd, 2011, pg. 10).”
- “The new government in 1994 inherited a legacy that could be characterized as follows: Previously the country’s water infrastructure had focused primarily on a population of about 6 million (comparatively affluent) whites, some people of colour in segregated urban townships, and on meeting the needs of the highly productive (and lucrative) industrial and agricultural sectors. The same infrastructure, after 1994, had to make provision for a population of more than 42 million people, of whom many were now living in informal settlements on the fringes of the country’s urban areas. Needless to say the existing infrastructure was simply inadequate (Kidd, 2011, pg. 11).”



- “A dedicated Basic Services Development Programme initiated in 1994 is eradicating the historic backlogs according to specific targets (which includes that) All people in South Africa have access to a functioning basic sanitation facility by 2014 (Department of Water Affairs, 2013).” There is, however, a ways to go as shown in Figure 24 and Figure 25.
- The installation of new sanitation facilities “increased the direct load on wastewater collection and treatment infrastructure substantially.” The focus on service provision was not supported by a similar focus on infrastructure provision to treat the wastewater generated as a result of these changes. (Mitchell et al., 2014, pg. 5).”
- “Rapid housing development under the new government coupled with increased urbanization has exacerbated the situation, since the water infrastructure has not kept pace with other development. (Kidd, 2011, pg. 45).”
- “The general increase in the affluence of the population, resulting in an improved quality of life and also an increasing use of resources [/] a higher level of consumption, increasing the per capita waste load generation (Mitchell et al., 2014, pg. 5).””
- “There will have to be considerable expenditure to remedy the situation” (Kidd, 2011)
- It will apparently cost R500 billion to address backlogs in sanitation services and to repair and increase the capacity of infrastructure, 30 to 40 per cent of which is not working (Kidd, 2011, pg. 46).”
- “The poor performance of wastewater treatment works (WWTWs) in protecting the health of the water resource has necessitated that the DWA take action to rectify the situation. The DWA has adopted a two-tiered approach (i.e. Green Drop and Blue Drop certifications). (Mitchell et al., 2014, pg 4).”

Community Sanitation Needs

(see page 2 for orientation map)

2012 Perspective
Community Sanitation Needs
Percentage of Population

- 0 %
- 1 - 25 %
- 26 - 50 %
- 51 - 75 %
- > 75 %

Sanitation Backlog
= 4.5 Million Households

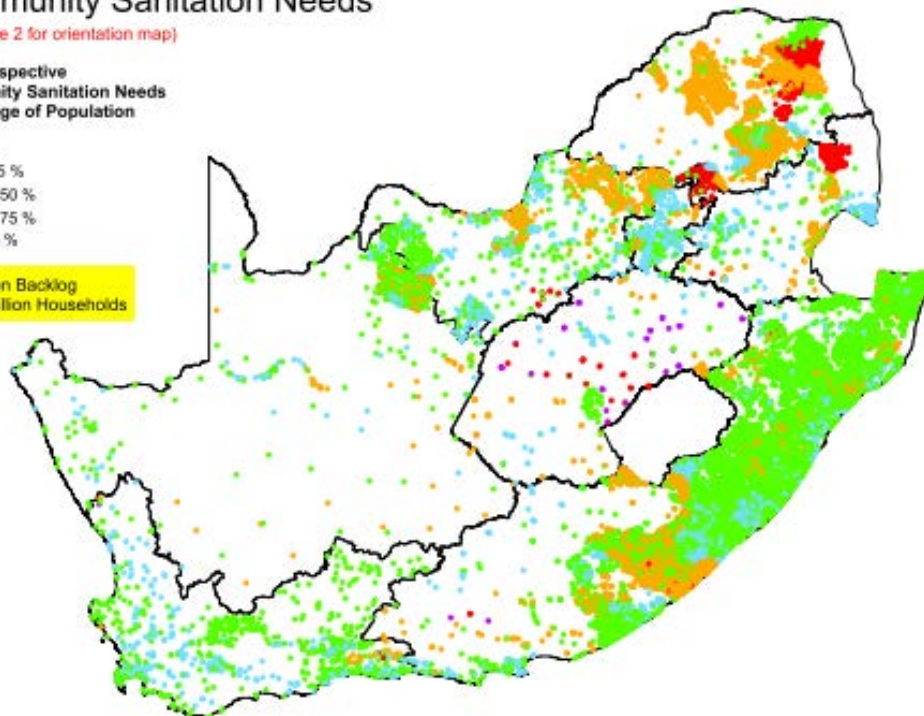

32

Strategic Overview of the Water Sector in South Africa 2013

Figure 24: Community Sanitation Needs (Department of Water Affairs, 2013, pg. 32)

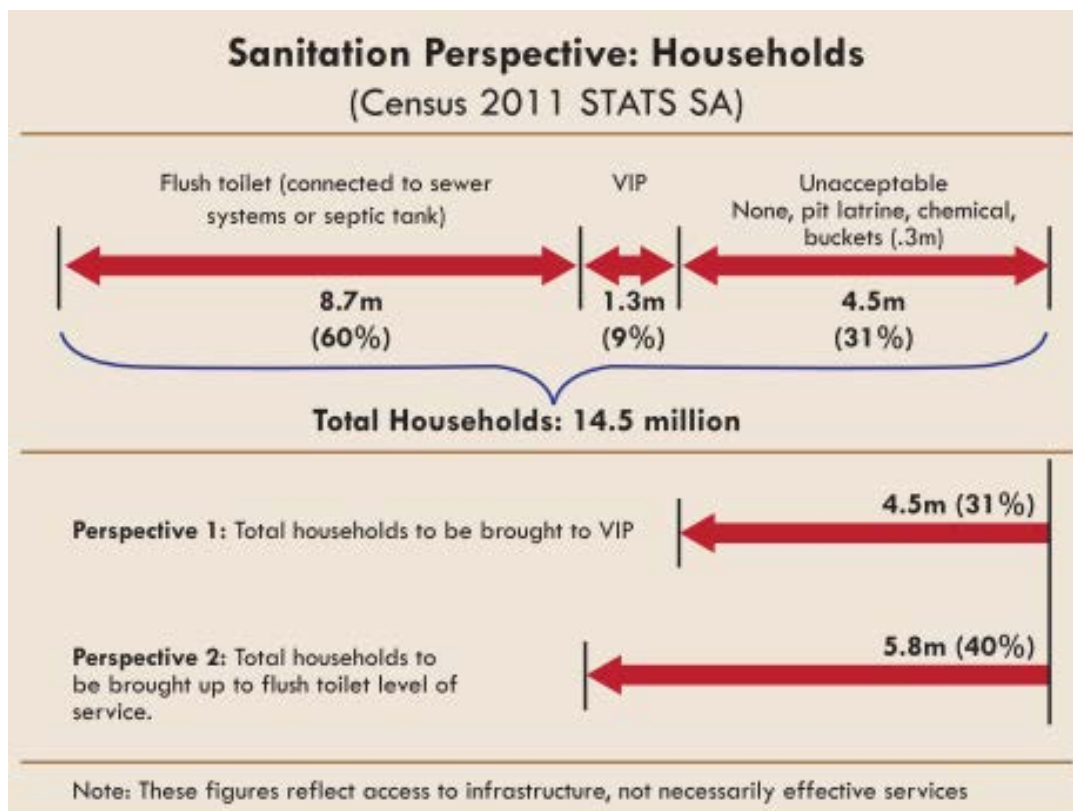

Figure 25: Household Sanitation Census data (SOURCE: Department of Water Affairs (2013), pg. 29)



3.3 Organization's Roles and Responsibilities

There are many organizations that play a role in wastewater treatment in South Africa. This section provides a short description of the major role and responsibilities.

The section draws extensively on three main sources:

- Kidd (2011) Poisoning the right to water in South Africa: What can the law do?
- Department of Water Affairs (2013) Strategic Overview of the Water Sector in South Africa
- Ntombela, Masangane, Funke, and Nortje (2013). Wastewater Treatment: Towards Improved Water Quality to Promote Social and Economic Development.

3.3.1 District and Local Municipalities

Ntombela, Masangane, Funke and Nortje (2013) explain the role of municipalities in wastewater treatment in *Wastewater Treatment: Towards Improved Water Quality to Promote Social and Economic Development*: “In terms of the Constitution, a municipality is an organ of state within the local sphere of government with the responsibility to, inter alia, ensure the provision of services to communities and promote a safe and healthy environment. Municipalities have the responsibility to administer the local government matters listed in Part B of Schedule 4 and Part B of Schedule 5 of the Constitution. Among the local government responsibilities listed in these Schedules is “water and sanitation services limited to potable water supply systems and domestic waste- water and sewage disposal systems”. This implies that municipalities are constitutionally obliged to provide water services to local communities with support and regulation by the provincial and national spheres of government. This duty encompasses wastewater management and forms part of sanitation services (pg. 3).”

The Department of Water Affairs (2013) explains further how local government (Metro, Local or District Municipalities) “act as the Water Services Authorities (WSAs) and often also Water Service Providers (WSPs) for all communities in their areas of jurisdiction (pg. 3).”

3.3.2 Water Services Authorities (WSAs) & Water Services Providers (WSPs)

Ntombela et al. (2013) define Water Services Authorities (WSAs) as “any municipality responsible for ensuring access to water services.” As set out in the Water Services Act, WSAs are responsible for planning, implementing and operating the necessary infrastructure to provide water services to their customers. Kidd (2011) says “One of the main objects of the WSA is to provide for the right of access to basic water supply and the right to basic sanitation necessary to secure sufficient water and an environment not harmful to human health or wellbeing (WSA s 2(a)). ‘Basic sanitation’ means the prescribed minimum standard of services necessary for the safe, hygienic and adequate collection, removal, disposal or purification of human excreta, domestic wastewater and sewage from households, including informal households (WSA s 1). ‘Sanitation services’ means the collection, removal, disposal or purification of human excreta, domestic wastewater, sewage and effluent resulting from the use of water for commercial purposes (WSA s 1 (pg. 10).” Figure shows Water Services Authorities by Type in South Africa.

Water Services Authorities by Type (WSAs)

(see page 2 for orientation map)

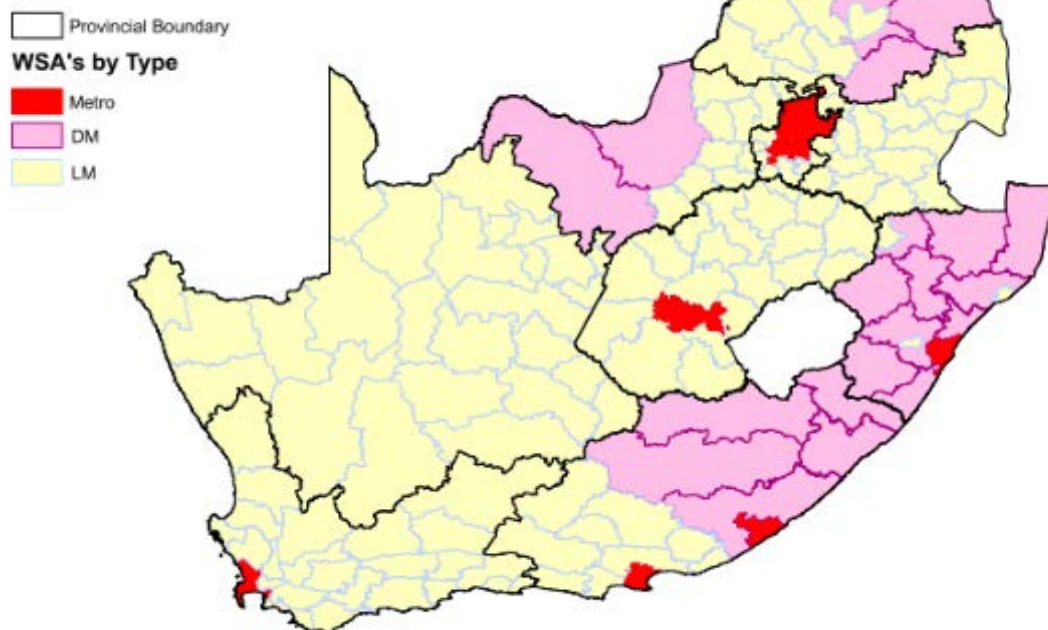

18

Strategic Overview of the Water Sector in South Africa 2013

Figure 26: Water Service Authorities by Type (Department of Water Affairs, 2013, pg. 18)

Ntombela et al (2013) continue, saying “All water services authorities are required to provide for measures to realise the right of access to basic water supply and basic sanitation, subject to stipulated conditions. In doing so, water services authorities have a duty to ensure efficient, affordable, economical and sustainable access to water services. (Ntombela et al., 2013).”

Water Service Providers (WSPs) provide water and/or sanitation services for municipalities. Ntombela et al. (2013) explain that “A water services authority can operate as a water services provider itself or may enter into an agreement with a water services provider or another water services institution to provide services. In cases where an agreement has been signed between a water services authority and a water services provider or another water services institution, a water services provider is responsible for managing such agreements with regulation and monitoring by DWAs. Water services authorities are also required to promulgate bylaws which set the conditions and standards for the provision of water services. (pg. 4)(Ntombela et al., 2013).” WSP entities can be made up of public, private or mixed entities, or municipal government itself.

The Department of Water Affairs (2013) explains further “some WSAs, where wastewater management is a regional challenge, have contracted out this function to bulk water services providers, however, the responsibility still rests with them to ensure an effective service (pg. 3).”

3.3.3 Water Utilities or Water Boards

DWS (2013) describes the role of water utilities or water boards: “Water utilities operate water resource infrastructure, manage bulk potable water supply schemes (selling water to municipalities and industries), and some retail water infrastructure and wastewater systems (pg. 14).”



Local municipalities can sign agreements with utility companies to meet the obligation of local government to provide residents with basic sanitation services. Bender and Gibson (2010) describe the 30-year concession agreement between Nelspruit and the Greater Nelspruit Utility Company, which was expected to inject capital and management resources into operations.

3.3.4 Department of Water and Sanitation

The Department of Water and Sanitation (DWS) is responsible for water resource protection and the overall regulation and monitoring of water services and operates at national, provincial and local levels (Ntombela et al., 2013). DWS must “ensure that wastewater will be treated to a quality consistent with the health-based and environment targets (van der Merwe-Botha & Manus, 2011, pg. 4).” The roles of DWS include setting limits, issuing licences, and regulating effluent releases. For example, van der Merwe-Botha and Manus (2011) explain that “the Department of Water Affairs has issued legislation and guidance documentation to ensure that monitoring is being undertaken according to “General and Special Standards: Government Gazette 18 May 1984 No. 9225: Regulation No. 991 18 May 1984: Requirements for the Purification of Wastewater or Effluent (pg. 71).” DWS monitors performance through a risk-based assessment called the “Green Drop” certification process (see below for more information).

3.3.5 Department of Cooperative Governance and Traditional Affairs (COGTA)

COGTA “ensures local government provides water services, regulates municipal services partnerships, ensures integrated municipal development planning, allocates funds to local government, regulates municipal affairs and with Provincial Government intervenes in cases of non-performing WSAs (Department of Water Affairs, 2013).”

COGTA looks at the business of the municipalities, including waster services (provision, financial and asset management). There are a number of DDGs, each given a province to look after in COGTA.

3.3.6 South African Local Government Association (SALGA)

SALGA is an autonomous political association of municipalities with its mandate derived from the 2006 constitution of the Republic of South Africa. William Moraka, who heads the water and sanitation efforts at the national SALGA office, says that the role of SALGA is to help municipalities function better. SALGA represents the interests of municipalities, provides support and offers advice. There are seven directorates, including: community development and collective bargaining issues. SALGA has provincial level that interfaces with municipalities at the local level.

3.3.7 National Treasury

“Treasury financially supports DWS and other national departments to fulfil their support and regulatory roles in so far as these roles relate to fiscal and financial matters (Department of Water Affairs, 2013).” Their inter-governmental team deal with provinces and local municipalities, including directly monitoring the 17 largest municipalities in Mpumalanga through National Treasury. The provincial department monitors the smaller municipalities.

National Treasury determines the allocation of equitable share and and rules around the MIG. For example, until very recently, MIG only allowed for the construction of new infrastructure.



National Treasury worked to change the rules for refurbishments. They are excited to work with AWARD to get feedback from the field. Treasury and COGTA work together to assure that municipal IDPs align with appropriate goals and have adequate budgets and expenditures. National treasury works to reconcile any adjustments in municipal expenditures.

The finance team at National Treasury also allocates funds to the Dept. of Water and Sanitation (DWS). The regional bulk infrastructure grant is channelled through this lump sum transfer.

3.3.8 Other national departments

Department of Human Settlements

The Department of Human Settlements sets national housing policy, which must be aligned to local government's water services policies. The Department is responsible for the eradication of water services backlogs in informal settlements and temporarily took over responsibility for sanitation between 2009 and 2013.

Department of Health

There are strong linkages between wastewater treatment, hygiene and health. The Department of Health is largely concerned about untreated discharge (which could, for example, contribute to diarrhoea or cholera outbreaks where fecal matter contaminates the water). There have been several instances of typhoid - most notably in Delmas, in Mpumalanga, where at least 13 people died in 2005 (NISC 2005-2008). There has been some discussion of trying to develop an early warning system.

In Phalaborwa, The Department of Health came and took samples and gave advice to the wastewater treatment works operators (pers. comm, 2015).

Department of Public Works

The Dept. of Public Works is responsible for implementing the community based public works programmes and often acts as the owner and operator of public buildings, including schools, hospitals—including some wastewater treatment works.

Department of Environmental Affairs

DEA ensures that environmental impact assessments for water services projects are carried out, while promoting conservation, cleaner technologies and waste minimization. "The purpose of these EIA-Regulations is to regulate the procedure and criteria relating to the submission, processing and consideration of, and decision on, applications for environmental authorisations for the commencement of activities in order to avoid detrimental impacts on the environment, or where it cannot be avoided, ensure mitigation and management of impacts to acceptable levels, and to optimise positive environmental impacts, and for matters pertaining thereto (Department of Public Works, 2012, pg.3)."



National Planning Commission

The National Planning Commission was established by the Presidency to develop “a long term vision and strategic plan and for advising on cross-cutting issues that impact on long term development.”

3.4 Rules, norms and standards

Much of the information on rules, norms and standards is available from the following reports:

- Boyd, L., & Mbelu, A. (2009). Guideline for the Inspection of Wastewater Treatment Works.
- Boyd, L., & Tompkins, R. (2011). A New Mindset for Integrated Water Quality Management for South Africa.
- Department of Public Works. (2012). Small Waste Water Treatment Works DPW Design Guidelines.
- Department of Water Affairs. (2013). Strategic Overview of the Water Sector in South Africa.
- Department of Water Affairs and Forestry. (2000). Water Use Authorisation Process. Pretoria.
- Kidd, M. (2011). Poisoning the right to water in South Africa: What can the law do?
- Malzbender, D., Earle, A., Deedat, H., Hollingworth, B., & Mokorosi, P. (2009). Review of regulatory aspects of the water services sector. Water Services.

3.4.1 Legislation

Van der Merwe-Botha and Manus (2011) say “The business of wastewater collection and treatment operates in a highly regulated environment. In this regard, the following Acts have particular reference (pg. 6).”

Constitution

As described in the Department of Water Affairs and Forestry (2000) report on the *Water Use Authorisation Process*, the Constitution “lays the foundation of a more just and equitable society. It guarantees everyone the right to an environment that is not harmful to their health or wellbeing and guarantees the right to have the environment protected, for the benefit of present and future generations, through reasonable legislative and other measures. It also guarantees all citizens the right of access to water (pg. 2).” The constitutional provisions contained in Chapter 2 pertaining to socio-economic rights require the State to “take reasonable legislative and other measures within its available resources, to achieve the progressive realisation of [these rights]”.

Water Services Act (WSA)

The DWAF (2000) report also outlines how the Water Services Act (WSA), No 108 of 1997, “provides the framework for the provision of water services. Developments for the provision of such water services will usually result in a water use that requires authorisation, irrespective the source of funding for such developments. This implies that the authorisation process should be followed in harmony with the funding mechanisms that are in place, as well as with the EIA-Regulations, if applicable. Wastewater management occurs at the interface between the WSA and National Water Act; the recent restructure of DWAS to addresses this matter.



National Water Act (NWA)

The National Water Act (NWA), 1998 (Act 36 of 1998) “introduces several new concepts, and regulates all water-related aspects in South Africa based on the above-mentioned Constitutional rights. The principles support the objectives of sustainability and equity which underpin the entire NWA as central guiding principles in the protection, use, development, conservation, management and control of our water resources (DWAF, 2000, pg. 2).” Malzbender, Earle, Deedat, Hollingworth, & Mokorosi (2009) explain further that the NWA states that “as the public trustee of the nation’s water resources the National Government, acting through the Minister, must ensure that water is protected, used, developed, conserved, managed and controlled in a sustainable and equitable manner, for the benefit of all persons and in accordance with its constitutional mandate.”

As Boyd and Tompkins (2011) explain “Section 21 of the National Water Act of 1998 defines all water uses that must be authorised.” The ‘discharging waste or water containing waste into a water resource through a pipe, canal, sewer, sea outfall or other conduit’ is a ‘water use’ in terms of the NWA and thus requires a license (NWA s22), which would specify the standards that the released treated water must meet (Kidd, 2011).” All WWTWs will fall within some sort of authorisation including:

- General Authorisations (GA) “If the treatment works is discharging less than 200 m³ of water per day, then it is subject to a general authorisation in terms of s39 of the NWA, which discharges the user from the requirement of a licence. Operating in terms of a general authorisation requires compliance with standards in any event (Kidd, 2011).”
- Existing Lawful Use (ELU)
- Water Use Licence (WUL)

“All of the authorisations are legal instruments that will have certain conditions, such quantity and quality issues that must be met. The authorisations may also refer to other relevant regulations or guidelines that must be met (Boyd and Tompkins (2011), pg. 77).”

“On the basis of the constitutional obligation to protect the environment, stringent pollution prevention measures and the “polluter pays” principle are incorporated into the NWA. According to Fundamental Principle 16: “Water quality management options shall include the use of economic incentives and penalties to reduce pollution and the possibility of irretrievable environmental degradation as a result of pollution shall be prevented”. In fulfilment of this principle “waste discharge charges”, as intended under section 56(5) of the NWA can be set for uses that may impact on the resource quality (DWAF, 2000, pg. 3).”

National Environmental Management Act (NEMA)

The National Environmental Management Act (NEMA), No 107 of 1998, “reiterates the provisions of section 24 of the Constitution, and contains the internationally accepted principles of sustainability. It is therefore a legal requirement that these principles must be taken into consideration in all decisions that may affect the environment. Furthermore, the need for intergovernmental co-ordination and harmonisation of policies, legislation, and actions relating to the environment, is emphasised.



It is also important to note that the Best Practical Environmental Option (BPEO) is defined in NEMA as “the option that provides the most benefit or causes the least damage to the environment as a whole, at a cost acceptable to society, in the long term as well as the short term (DWAF, 2000, pg. 2)”.

NEMA states that before certain listed development activities can be undertaken, an EIA must be undertaken and Environmental Authorisation obtained.

Environmental Conservation Act

Provisions dealing with waste management are under section 20 under the Environmental Conservation Act.

Occupational Health and Safety Act No 85 of 1993

A WWTW is a “production” process and is required to comply with the OHSA. The plant must be designed to adhere to the regulations and requirements of the OHSA

3.4.2 Policy

A number of policies also affect wastewater treatment in South Africa. These include:

DWA Water Supply and Sanitation Policy, 2001

“Speaks primarily to basic sanitation in a context where rural households use on-site dry toilets. It is silent on what sanitation improvement means in a context of urban reticulated services, and says almost nothing about grey water and wastewater management (Eales, 2011, pg. 80).”

White Paper on National Sanitation Policy

The national water act (Act 54 of 1956) is aimed at ensuring the equitable distribution of water for industrial and other competing users as well as to authorise strict control over the abstraction, use, supply, distribution and pollution of water, artificial atmospheric precipitation and the treatment and discharge of effluent. According to the Policy, the wealthier municipalities were allocated with greater quantities of water required for water borne sewage services and the poor communities were left with the bucket systems which are still in use today.

4 Institutional framework

The aim of the framework in the Water Supply and Sanitation Policy, is to ensure that the existing institutional capability of water supply and sanitation provision is maintained in the short run.

Policy of the Department of Water Affairs Act communities to have access to basic services and the support they need to achieve them.



Institutional goals of government with regards to water supply and sanitation services

In the long run:

The provision of services to consumers should be a function of competent, democratic local government supported by provincial government.

Medium Term goals:

Government support institutional support development at local levels and to provide financial and technical assistance for the development of water supply and sanitation services through restructured Department of Water Affairs and Forestry (DWS) and through water boards in collaboration with NGO and Private sector.

The water supply and sanitation policy is based on the 10 principles of:

1. Development should be demand driven and community based
2. Basic services are a human right
3. “Some for All” rather than “All for Some”
4. Equitable regional allocation of development resources
5. The user pays
6. Water has an economic value
7. Integrated development
8. Environmental Integrity
9. Sanitation is about health
10. Sanitation is a community responsibility

The water supply and sanitation policy underlines the role of the central government, the role of the provincial government and the role of the local government in the provisioning of the water and sanitation services.

- The central government manages the nation’s water resources in the public interest and ensure that all citizens have access to adequate water and sanitation services.
- The role of the provincial government:
 - “.....make provision for access by all persons residing within its area of jurisdiction to water, sanitation [and other services]..... providing that such services and amenities are rendered in an environmentally sustainable manner and are financially and physically applicable.....”.
- The role of the local government is to ensure that sustainable water and sanitation development exist and are functional and competent. The local government will ensure that the water boards are expanded to provide and supply water and sanitation services to the final consumer. The minister of Water Affairs and Forestry will be empowered to establish statutory local water committees to undertake the task of local water and sanitation service provision.



5 Factors determining institutional arrangements

1 Promotion and support requirements

Programmes in developing areas may require more attention to “soft” issues such as community empowerment, promotion, health, education and financial assistance to households. Other support may be needed to assist emerging entrepreneurs to participate.

2 Financial and economic constraints

Institutional arrangements will differ in those communities with a financially sound local government from those in which local government does not have adequate financial means.

3 Technical and environmental issues

Technologies used where sanitation serve an entire community will be different from those that serve only individual households and environmentally vulnerable areas will be given special care.

4 Management requirements

A communal sewerage system requires a dedicated management system to ensure its ongoing operation and maintenance. This is less so for household on-site systems which may only require emptying or replacement once every five years, but will still be needed if such systems are to be effective.



The linkages of the Water and Sanitation policy to other programmes are shown in the diagram below.

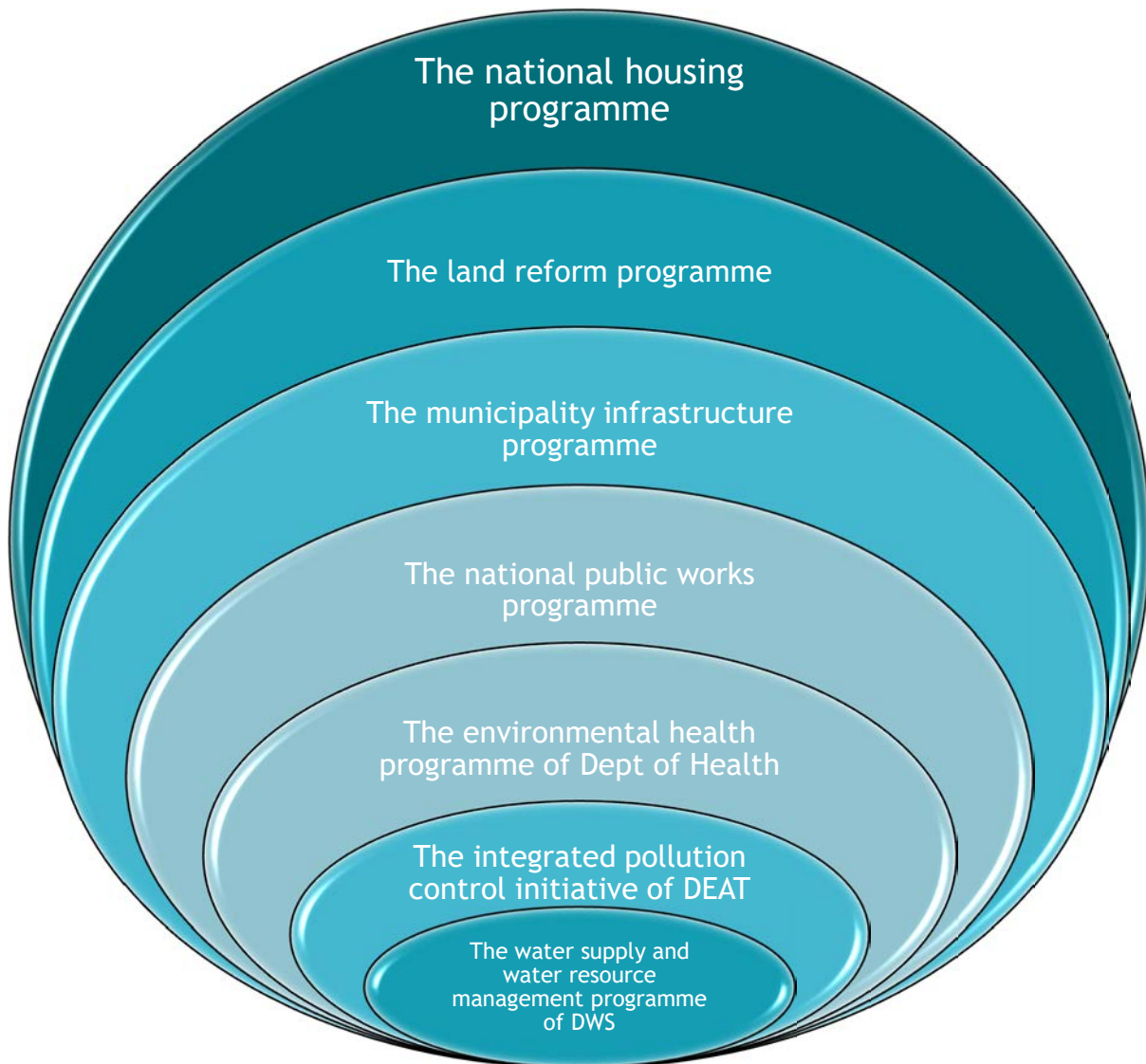

- DWS community based water supply programmes which provide a platform for implementation of sanitation activities through local water and sanitation committees supporting the development of local government structures.

[Towards a Water Services White Paper](#)
[Policy on Hazardous Waste Management](#)

The Department of Public Works (2012) explains “the principle that the polluter should pay for the negative environmental consequences of disposal or discharge actions is incorporated in the Policy on Hazardous Waste Management (September 1994) (pg. 8).”

[White paper on Local Government](#)
[White Paper on Municipal Service Partnerships](#)

5.1.1 Plans

Wastewater treatment is underpinned by several municipal planning requirements, such as the budget, Integrated Development Plan (IDP), Water Services Development Plans (WSDP), Quality Management Systems, Infrastructure Asset Management Plans and Levels of Service, as shown in Figure 27 and explained in more detail below (van der Merwe-Botha & Manus, 2011). These are explained in some detail below and show in relation to each other in Figure 27.

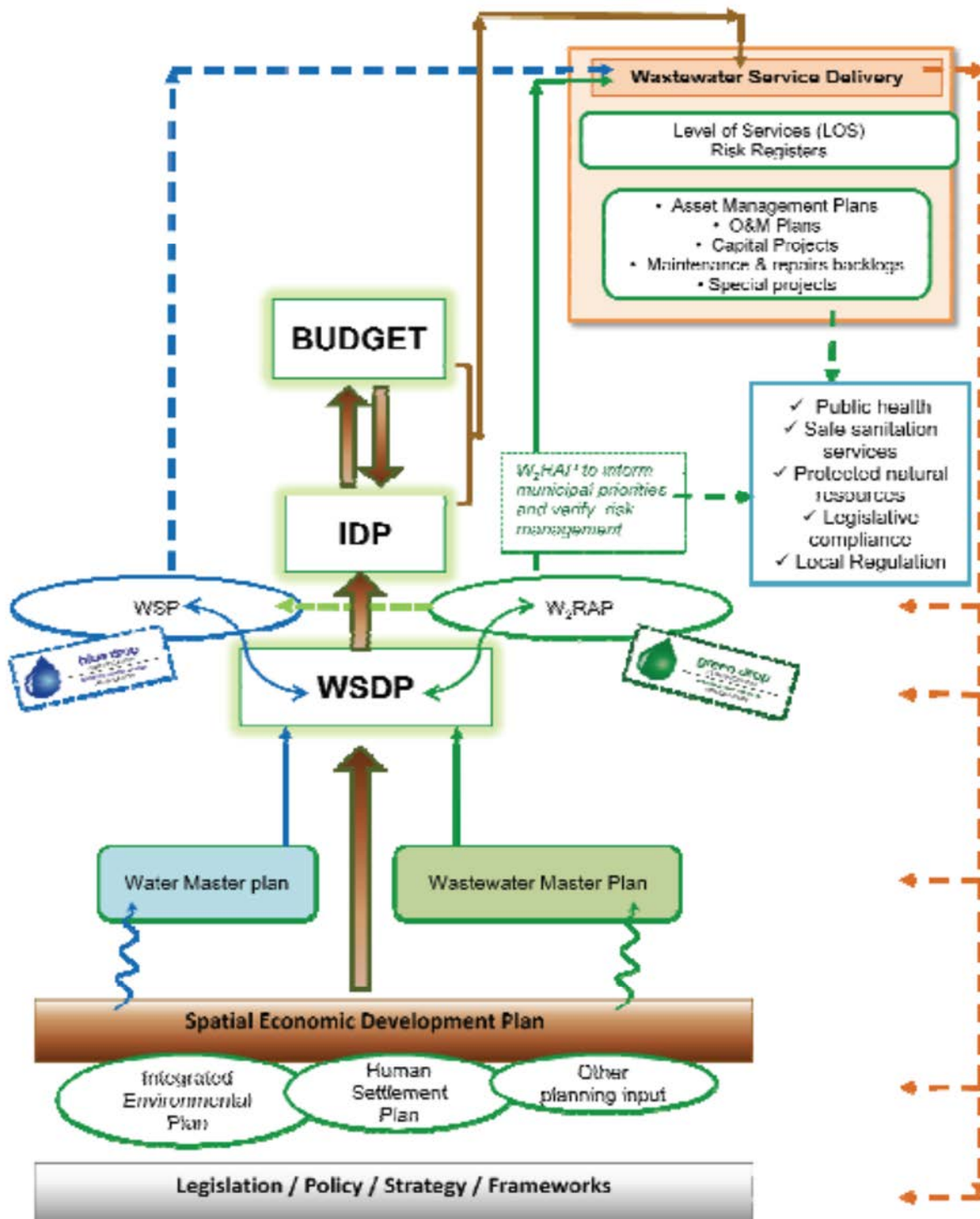

Figure 27: Linkages between the most essential municipal business processes.
 SOURCE: van der Merwe-Botha & Manus, 2011, pg. 8



Integrated Development Plan

The **Integrated Development Plan (IDP)** is “the strategic development plan for a municipal area containing short, medium and long-term objectives and strategies. It serves as the principal decision-making and management instrument for municipalities linking developments with the multi-year municipal budget. It is legislated by the Municipal Systems Act 2000 (MSA) and supersedes all other plans that guide development at a local level. The purpose of IDP is to foster integrated and appropriate service delivery by providing the framework for economic and social development within the municipality identified (van der Merwe-Botha & Manus, 2011, pg. 7).”

Water Services Development Plan

The primary municipal water services planning and management instrument is the Water Services Development Plan (WSDP). “All Water Service Authorities (WSAs) must develop a 5 year WSDP which must be updated on an ongoing basis. The WSDP indicates how the WSA plans to provide universal access to water services, including the eradication of historical backlogs within its area of jurisdiction. The WSDP integrates technical, social, institutional, financial and environmental planning and feeds into the Integrated Development Planning (IDP) process. The WSA must report annually against the WSDP. A WSDP Guideline document, developed by the DWA can be utilized by municipalities to develop and update their WSDPs. Currently the DWA has received 140 draft or interim WSDPs and 10 Council approved WSDPs. Only two WSAs have not submitted any WSDP. The WSDP status countrywide can be viewed on the DWA website (Department of Water Affairs, 2013, pg. 25).” “Water services authorities are required to report on the implementation of these plans every year. (Ntombela et al., 2013).”

Environmental Management Plan

“The Environmental Management Plan (EMP) is recognised as the tool that can provide the assurance that the project proponent has made suitable provisions for mitigation. The EMP is the document that provides a description of the methods and procedures for mitigating and monitoring impacts. The EMP also contains environmental objectives and targets which the project proponent or developer needs to achieve in order to reduce or eliminate negative impacts. The EMP document can be used throughout the project life cycle. It is regularly updated to be aligned with the project progress from construction, operation to decommissioning. EMPs provide a link between the impacts predicted and mitigation measures specified within the Environmental Impact Assessment (EIA) report, and the implementation and operational activities of the project. EMPs outline the environmental impacts, the mitigation measures, roles and responsibilities, timescales and cost of mitigation. NEMA states that before certain listed development activities can be undertaken, an EIA must be undertaken and Environmental Authorisation obtained. The Department of Environmental Affairs and Development Planning is responsible for evaluating applications in terms of the EIA Regulations. This written decision is now called either an Environmental Authorisation or Environmental Refusal and is listed in an Environmental Authorisation (EA). The full statute can be accessed from www.info.gov.za (“Environmental Management Plans,” n.d.).



Wastewater Risk Abatement Planning (W₂RAP)

The introduction to the Green Drop program says, “Wastewater treatment is the first barrier in a multi-barrier system of ensuring public- and environmental health. In the same way that the Water Safety Plan identifies, plan and manage the risks in the drinking water treatment and supply systems, does the W₂RAP identify, plan and manage risks in the wastewater collection and treatment system (Department of Water Affairs, 2011).” The development of the South African W₂RAP Guideline for Municipalities drew on principles and concepts of other risk management procedures, such as the Water Safety Plan and Hazard Analysis and Critical Control Points. The aim is “to encourage municipalities to use risk abatement in their business decision making processes. It also encourages methodical thinking, as well as a more proactive and pragmatic approach towards improved wastewater service management.”

Municipal Water Quality WORKplan

“The “Municipal Water Quality WORKplan” has been developed to guide municipalities towards meeting the 2014 Presidential Targets for wastewater quality, as well as improved Green Drop performance. The WORKplan seeks to i) hold up a benchmark on what world best-practice identifies as core values that enable improved organization performance and ii) sets out a WORKplan for the South African water sector, whereby municipal management and national regulation authorities can focus effort and work towards improved and sustainable water and wastewater management. This plan builds on the existing Green Drop Certification programme, as well as the risk-based approach as outlined in the W₂RAP, to formulate the calendar and targets for regulation in the sector as they impact on local government. In short, the WORKplan spells out the foreseeable future of water and wastewater quality in the country, and the key areas that will drive change and the milestones that will determine if progress is on par with planning (Department of Water Affairs, 2011).

Other Plans

There is also the Integrated District Waste Management Plan, Water Safety Planning Process (WSPP) which describes “how risks associated with poorly managed wastewater treatment can be abated,” and a Quality Management System (QMS), such as ISO 9001, which “serves as a guide for O&M Plan’s successful implementation and risk management. The QMS would include Standard Operating Procedures, data capturing, training, equipment malfunction reporting, preventative and mitigation and verification of input data. Such system thereby becomes one of the appropriate measures to be taken against certain risk and hazards identified (van der Merwe-Botha & Manus, 2011, pg. 7). Some municipalities have developed Infrastructure Asset Management Plans and Disaster Management Plans. As Ntombela et al. (2013) say, “With the different development plans in place, the question that arises is how these plans can be implemented effectively (pg. 2).”

5.1.2 Strategies & guidelines

Some of the relevant strategies and guidelines for treating wastewater are listed below.

- A Guide to the Design of Sewage Purification Works

This document was written by the Institute for Water Pollution Control, Southern Africa, November 1973, for design guidelines.

- 2003 Strategic Framework for Water Services



- 2010 Guidelines - wastewater discharge standards
- Local Government Turn Around Strategy (LGTAS)
- South African Water Quality Guidelines

The South African Water Quality Guidelines comprise of a series of eight volumes:

1. Volume 1: South African Water Quality Guidelines - Domestic Water Use
 2. Volume 2: South African Water Quality Guidelines - Recreational Water Use
 3. Volume 3: South African Water Quality Guidelines - Industrial Water Use
 4. Volume 4: South African Water Quality Guidelines - Agricultural Water Use: Irrigation
 5. Volume 5: South African Water Quality Guidelines - Agricultural Water Use: Livestock Watering
 6. Volume 6: South African Water Quality Guidelines - Agricultural Water Use: Aquaculture
 7. Volume 7: South African Water Quality Guidelines - Aquatic Ecosystems
 8. Volume 8: South African Water Quality Guidelines - Field Guide
- Strategic Framework for Water Services
 - Draft National Water Services Regulation Strategy

5.2 Regulation

5.2.1 Limits and Standards

Licenses and Effluent Discharge Standards

The degree to which wastewater treatment processes achieve improvements in the quality of the wastewater is closely related to the standards set for the effluent quality (World Bank, 2014). DWS is meant to stipulate effluent discharge standards for each WWTW in the water use licence. The standards for discharging wastewater into a water resource are either general standards or specific standards; these may include, but are not limited to, the parameters shown in the table below:



TABLE 6: EFFLUENT DISCHARGE STANDARDS (FROM THE GENERAL AUTHORISATION, SECTION 39 OF THE NATIONAL WATER ACT NO 36 OF 1998)

	SUBSTANCE/PARAMETER	GENERAL LIMIT	SPECIAL LIMIT
PHYSICAL	Colour, odour or taste	The wastewater or effluent shall not contain any substance in a concentration capable of producing any colour, odour or taste	The wastewater or effluent shall not contain any substance in a concentration capable of producing any colour, odour or taste
	Suspended Solids (mg/l)	25	10
	Temperature	Shall be a maximum of 35 degrees Celsius	Shall be a maximum of 25 degrees Celsius
MICROBIO	Faecal Coliforms (cfu/per 100 ml)	1 000	0
CHEMICAL	Ammonia as Nitrogen (mg/l)	06-Mar	2
	Boron (mg/l)	1	0.5
	Chemical Oxygen Demand (mg/l)	75	30
	Chlorine as Free Chlorine (mg/l)	0.25	0
	Dissolved Arsenic (mg/l)	0.02	0.01
	Dissolved Cadmium (mg/l)	0.005	0.001
	Dissolved Chromium (VI) (mg/l)	0.05	0.02
	Dissolved Copper (mg/l)	0.01	0.002
	Dissolved Cyanide (mg/l)	0.02	0.01
	Dissolved Iron (mg/l)	0.3	0.3
	Dissolved Lead (mg/l)	0.01	0.006
	Dissolved Manganese (mg/l)	0.1	0.1
	Dissolved oxygen	Shall be at least 75 per cent saturation	Shall be at least 75 per cent saturation
	Dissolved Selenium (mg/l)	0.02	0.02
	Dissolved Zinc (mg/l)	0.1	0.04
	Electrical Conductivity (mS/m)	70 mS/m above intake to a maximum of 150 mS/m	50 mS/m above receiving water
	Fluoride (mg/l)	1	1
	Mercury and its compounds (mg/l)	0.005	0.001
	Nitrate/Nitrite as Nitrogen	15	1,5
	Ortho-Phosphate as phosphorous (mg/l)	10	1 (median) and 2,5 (maximum)
	ph	5,5-9,5	5,5-7,5
	Soap, oil or grease (mg/l)	2.5	0
	Sodium content	Not to be increased by more than 90 mg/l above the intake water	Not to be increased by more than 50 mg/l above of the intake water
Sulphides (as S ₀) (mg/l)	1	0.05	



“The frequency of monitoring for compliance will also be stipulated in the water use authorisation (Boyd, 40).”

“Apart from above ‘compliance’ limits and standards, it is also good practice to establish operational limits and standards within the municipal systems. These limits are not legally enforceable, but if set and managed, will result in compliance to legally set limits such as final effluent quality (van der Merwe-Botha & Manus, 2011, pg 80).

“An additional problem is that, even if treatment works are in compliance with the relevant standards, the standards are so-called uniform effluent standards so they do not take into account the cumulative effect of discharge of numbers of separate effluent streams into a water resource, which is often a cause of excessive nutrient loading. (Kidd, 2011).”

5.2.2 Regulation

“Regulation is important to ensure effective and efficient delivery of sustainable water services [...] It clarifies the requirements and obligations placed on water service institutions, thereby protecting consumers from a potentially unsustainable and unsafe service (Green Drop Report).”

Green Drop Certification Programme for Wastewater Quality Management Regulation

The Green Drop programme is a national effluent quality incentive-based regulation initiative which identifies and develops the core competencies required for the sector as a means of “facilitating a gradual and sustainable improvement in wastewater management performance in South Africa.” The Green Drop process measures and compares aspects of Water Service Authorities and their Providers performance according to minimum standards or requirements that have been defined (Mitchell et al., 2014), and “subsequently rewards (or penalises) the municipality upon evidence of their excellence (or failures).”

In addition to providing a benchmark, the scoring system provides an incentive to WSAs: WWTWs which perform properly across a number of aspects are awarded Green Drop status. Customers, the media, political classes and NGOs are meant to pressure mediocre performing municipalities to correct the identified shortcomings.

Green Drop Scoring

Municipal Green Drop Score: The Municipal Green Drop score is a Performance Indicator of the overall municipal wastewater business. Nine key performance areas are assessed and weighted:

1. Process Control, Maintenance & Management skills
2. Monitoring Programme
3. Credibility of Sample Analyses
4. Submission of Results
5. Wastewater Quality Compliance
6. Failure Response Management
7. Bylaws
8. Treatment & Collector Capacity
9. Asset Management



The scorecard, which according to the Department of Water Affairs (2011) “outlines the key requirements of the Green Drop assessment and indicates the Portfolio of Evidence that was required by each municipality to calculate a Green Drop score per wastewater system,” are:

TABLE7: KEY REQUIREMENTS FOR GREEN DROP CRITERIA (GREEN DROP INTRODUCTION, 2011)

GREEN DROP CERTIFICATION 2010/11			
No	GREEN DROP CRITERIA	REQUIREMENTS	SUB-REQUIREMENTS
1	Process Control, Maintenance and Management Skill <i>Primary weight 10</i>	A copy (certified) of Registration Certificate of Works displaying Classification (R2834)	<ul style="list-style-type: none"> ✓ Copy of registration certificate must be uploaded on the GDS
		Copies (certified) of Registration Certificates of Process Controllers and Supervisors	<ul style="list-style-type: none"> ✓ Copies of the classification certificates must be uploaded on GDS ✓ WSI must indicate shift patterns ✓ Proof of qualifications & experience of shift workers performing process controlling tasks ✓ Compliance with R2834 WSI must indicate process controllers and / or supervisors shared across different works / sites
		Proof of Maintenance Team used for general maintenance work at the plant (both mechanical & electrical)	<ul style="list-style-type: none"> ✓ Information on in-house or external contractor, SLA arrangement ✓ Contract or Logbook with maintenance entries will serve as proof ✓ Additional proof required on team competency ✓ Provide additional proof of competency of team (e.g. Qualification & Experience & Trade-test)
		Proof of a 'site-specific' Operation & Maintenance Manual	<ul style="list-style-type: none"> ✓ Front page and index required for submission, but sufficient content must be proven ✓ O&M manual to contain: structural, mechanical, electrical detail of plant, design specifications of plant, reference to drawings, operational schedules, maintenance schedules, process detail and control, instrumentation specification/type, fault finding, monitoring, pump curves, supportive appendices
<ul style="list-style-type: none"> ✓ BONUS: Proof of Process Controller staff being subjected to relevant training the past 12 months 			
2	Wastewater Quality Monitoring Programme <i>Primary weight 10</i>	Details of sampling sites; determinants and frequencies of Operational Monitoring	<ul style="list-style-type: none"> ✓ Proof of Operational Monitoring Sites; Determinants and Frequency ✓ Samples must include: inflow, outflow, process flows, industrial effluent, sludge. Determinants as per License / Permit / Authorisation. Frequency as per License / Permit / Authorisation or Best practice for particular technology type & size of works
		Details of sampling sites; determinants and frequencies of Compliance Monitoring	<ul style="list-style-type: none"> ✓ Proof of Compliance Monitoring Sites, Determinants & Frequency as per specification in license / GA / permit / registration (including catchment monitoring; up / downstream samples) ✓ Sludge monitoring and classification as per WRC Sludge Guidelines ✓ * Note: for zero-effluent treatment systems - still need to monitor for impact on catchment / environment (for both lined & unlined systems) * Applicable to oxidation ponds as well







3	Wastewater Sample Analysis (credibility) <i>Primary weight 5</i>	Provide proof and the name of the Laboratory used	✓ Name lab for operational analysis (in-house or on-site) and lab for compliance analysis (in-house or external)
		Certificate of Accreditation for applicable methods OR Z-scores results ($-2 \leq z\text{-score} \leq 2$ are unacceptable) in a recognised Proficiency Testing Scheme. OR proof of Intra- and Inter-laboratory proficiency (quality assurance as prescribed in Standard Methods)	✓ Check if laboratory is accredited to perform the specific methods ✓ Check acceptability of Z-scores for the water quality determinants
		Explanation on how monitoring results are used to amend / improve process controlling	✓ Practical example [The assessor will select at random analytical parameter/s from the presented analytical results to present an audit question]
		BONUS: Monitoring at an acceptable frequency and for the required determinants	✓ Proof to be provided that WSI maintains a 100% monitoring trend at an acceptable minimum frequency against a full set of required process determinants. Best practice indicators: low-end techn/small size = 1x-2x/month, medium size = 1x-2x/week, high techn/macro size = 1x/day or hourly
4	Submission of Wastewater Quality Results <i>Primary weight 5</i>	Proof of data submission to DWA (12 months)	✓ 12 months of data submitted to DWA on the GDS. ✓ WSIs must ensure that 12 months' sets of results are recorded on GDS. ✓ Note: All compliance results data required to award full score
5	Wastewater Quality Compliance <i>Primary weight 30</i>	Copy of effluent quality limits or standards used to calculate compliance (e.g. effluent limits or standards as per license, General Authorisation, or Permit)	✓ Authorisation proof, contains the specified effluent quality limits or standards for discharge to a water body / or for irrigation / for industrial use / or for other applications
		Effluent Quality CATEGORIES: 90% Microbiological compliance; 90% Chemical compliance & 90% Physical compliance	✓ 90% Compliance with all 3 Effluent Quality CATEGORIES (If not Authorised; 8x General Authorisation Limits apply) ✓ Note: 90th percentile compliance considered in case of large data sets to be assessed as performance measure
		Bonus	✓ A practical and acceptable wastewater Management Rectification plan (or Wastewater Risk Abatement Plan; W ₂ RAP) is in place to address inefficiencies/inadequacies that result in non-compliance ✓ Plan must indicate priorities, timeframes and resource definition
		Penalty	✓ No proof of valid Authorisation (or sufficient proof of Application)
6	Wastewater Quality Failures Response Management <i>Primary weight 10</i>	Proof of a documented wastewater Incident Management Protocol	✓ Protocol to specify alert levels, response times, required actions, roles & responsibilities and communication vehicles ✓ NB. Include pump station failure
		Provide evidence of implementation of Protocol	✓ Wastewater Quality Failure & Sewer Spillage Incident register

7	Stormwater and Water Demand Management <i>2010/11 not assessed</i>	Proof of a Stormwater management plan detailing how stormwater will be prevented from entering sewer systems and how sewer spillages or sewerage from entering stormwater. Evidence of implementation required	<ul style="list-style-type: none"> ✓ Copy of front page and contents pages + Implementation proof ✓ WSI must have knowledge of baseline figures (e.g. measured % or volumetric rates of infiltration)
		Water Demand Management Plan including a practical strategy to address artificial water demand due to leakages and non-sewer infiltration, causing higher hydraulic loading of wastewater collector and treatment infrastructure. (Might include the need for a wastewater balance)	<ul style="list-style-type: none"> ✓ Copy of Strategy or Implementation Plan, Implementation proof ✓ WSI must have knowledge of baseline figures (e.g. measured % or volumetric rates of losses)
8	Bylaws <i>Primary weight 5</i>	Proof of the Bylaws providing for the regulation of industrial (trade) effluent (volumes & quality) discharged into municipal system, package plants, decentralized systems, vacuum tank discharges and spillages into the environment	<ul style="list-style-type: none"> ✓ Copy of front page, Index and portion referring to industrial/trade effluent
		Evidence of Bylaws enforcement by Local Authority	<ul style="list-style-type: none"> ✓ Proof of application of Bylaw clause in practice, supported by written notice(s) to offender
9	Wastewater Treatment Facility Capacity <i>Primary weight 10</i>	Documented design capacity (hydraulic and organic) of the wastewater treatment facility. Documented daily receiving flows over the 12 months of assessed period (ideally < than design capacity)	<ul style="list-style-type: none"> ✓ Design capacity as Average Dry Weather Flow (ADWF) and COD load to the plant. ✓ Evidence of daily flows and subsequent calculated averages. ✓ Measurement method to be explained Assessor may request proof of calibration certificates of inflow meters to verify accuracy of data
		Medium to long term planning to ensure sufficient capacity for treatment system and to ensure effluent quality compliance	<ul style="list-style-type: none"> ✓ Detailed Workplan which stipulates type of work, associated budget and projected timeframe, as well as the planned output of this work
		Medium to long term planning to ensure sufficient capacity for collecting system	<ul style="list-style-type: none"> ✓ Detailed Workplan which stipulates type of work, associated budget and projected timeframe, as well as the planned output of this work
10	Publication of Wastewater Management Performance <i>2010/11 not assessed</i>	Annual Publication of wastewater management performance against the requirements of the site-specific License conditions or General Authorisations	<ul style="list-style-type: none"> ✓ Name and date of publication, copy of information pertaining to audit question. ✓ Note: Level of detail must include compliance detail
		Publication in various communication mechanisms to reach wider audience, in particular information to the public	<ul style="list-style-type: none"> ✓ Evidence / Copy of publication in each media form. ✓ Electronic (web) good but not entirely sufficient. ✓ Web-based reporting will equate to 40% of this sub-criteria score



The performance areas are assigned a color-coded score, as shown in Table 8.

TABLE 8: COLOUR CODES AND APPROPRIATE ACTION BY MUNICIPALITY FOR PERFORMANCE AREAS ASSESSED FOR GREEN DROP CERTIFICATION

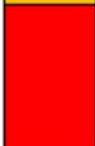
Colour codes		Appropriate action by municipality
	90-100%	Excellent situation, need to maintain via continued improvement
	80-<90%	Good status, improve where gaps identified to shift to 'excellent'
	50-<80%	Average performance, ample room for improvement
	31-<50%	Very poor performance, need targeted intervention towards gradual sustainable improvement
	0-<31%	Critical state, need urgent intervention for all aspects of the wastewater services business

Assessments are conducted by a panel consisting of a qualified wastewater professional as Lead Assessor, 2-4 Assessors and a Learner Assessor who also coordinate the logistical arrangements of the assessments.

Risk-based Regulation in South Africa

The introduction to the 2012 Green Drop progress update says “Whilst the Green Drop assessment focuses on the entire business of the municipal wastewater services (entire value chain), the risk analysis focuses on the wastewater treatment function specifically. This allows the Regulator to have insight into the treatment component of the municipal business, which is one of the high risk components within the production chain. Risk-based regulation allows the municipality to identify and prioritise the critical risk areas within its wastewater treatment process and to take corrective measures to abate these. Risk analysis is used by the Regulator to identify, quantify and manage the corresponding risks according to their potential impact on the water resource and to ensure a prioritised and targeted regulation of high risk municipalities.”

Cumulative Risk Rating

Van der Merwe-Botha and Manus (2011) explain that “Risk-based regulation focuses on the wastewater treatment function specifically. This allows the Regulator to have insight into the treatment component within the business, which is one of the high risk components within the production chain. Risk analysis is used by the Regulator to identify, quantify and manage the corresponding risks according to their potential impact on the water resource and to ensure a prioritised and targeted regulation of high risk municipalities (van der Merwe-Botha & Manus, 2011, pg. 9).”



The introduction to the 2012 Green Drop Progress Update continues by explaining, “[r]isk is defined and calculated by the following formula:

$$\text{Cumulative Risk Rating (CRR)} = A \times B + C + D$$

where:

- A = Design Capacity of plant which also represent the hydraulic loading onto the receiving water body
- B = Operational flow exceeding-, on- and below capacity
- C = Number of non-compliance trends in terms of effluent quality as discharged to the receiving water body
- D = Compliance or non-compliance i.t.o. technical skills

[...] A CRR %deviation is used throughout the Report to indicate that variance of a CRR value before it reaches its maximum CRR value. The higher the CRR %deviation value, the closer the CRR risk is to the maximum value it can obtain.

Example 1: a 95% CRR %deviation value means the plant has only 5% space remaining before the system will reach its maximum critical state (100%).

Example 2: a 25% CRR% deviation value means the plant holds a low and manageable risk position and is not close to the limits that define a critical state (90-100%).

CRR %deviation is calculated as $\text{CRR value} / \text{CRRmax} \times 100 = \text{CRR \%deviation (as \%)}$

A CRR% deviation is used throughout the Report to indicate that variance of a CRR value before it reaches its maximum CRR value. The higher the CRR% deviation value, the closer the CRR risk is to the maximum value it can obtain.

Similarly, a % i.t.o. Maximum Risk Rating is the score that is sensitive towards the “treatment” function of the service. This score indicates the percentage in terms of the maximum possible CRR of the specific WWTP. An **orange** and **red** score indicate that the plant is already in high- or critical risk that warrants urgent attention. A \uparrow arrow shows a trend of increase risk (digression), whilst a \downarrow shows risk is being reduced (improved) upon comparison with the 2009 risk profile.”

Supply Chain Management Regulation

“Supply Chain Management Regulation is the imperative to ensure compliance with the Municipal Finance Management Act and specifically, the SCM regulations. These procedures do tend to be cumbersome and delays the effective and efficient response to wastewater collection and treatment’s operational and maintenance needs. The stringent regulations are unlikely to change as these are legislative requirements. However, the W2RAP and O&M Plan need to take this into account and put plans and mitigation measures in place for emergencies, breakdowns, reactive repairs and associated costs. (Kidd, 2011).”

5.3 Compliance, monitoring and enforcement

[Please see future AWARD report for how WWTWs factor into broader water resource management (WRM) compliance, monitoring and enforcement.]



6 Works Cited

- Bender, P., & Gibson, S. (2010). Case Study for the 10 years of the Mbombela (Nelspruit) Water and Sanitation Concession South Africa.
- Boyd, L., & Mbelu, A. (2009). Guideline for the Inspection of Wastewater Treatment Works. Republic of South Africa: Water Research Commission.
- Boyd, L., & Tompkins, R. (2011). A New Mindset for Integrated Water Quality Management for South Africa. *Water Resources Development*, 27(01), 203-218.
- Brown, J. R. (2001). Wastewater Treatment Works Class I-S Study Guide. Charleston, West Virginia: West Virginia Department of Health and Human Resources.
- Cheremisinoff, N. P. (1994). *Handbook of Water and Wastewater Treatment Technology* (Vol. 9). CRC Press. Retrieved from https://books.google.com/books?id=B_d40rH_1GoC&pgis=1
- City of Lee's Summit. (2014). Inflow and Infiltration. Retrieved January 15, 2015, from [http://cityofls.net/Utilities/Wastewater-System/Inflow-and-Infiltration-\(I-I\).aspx](http://cityofls.net/Utilities/Wastewater-System/Inflow-and-Infiltration-(I-I).aspx)
- Department of Public Works. (2012). Small Waste Water Treatment Works DPW Design Guidelines.
- Department of Water Affairs. (2010). Wastewater Risk Abatement Plan: A Guideline to plan and manage towards safe and compliant wastewater collection and treatment in South Africa. Republic of South Africa.
- Department of Water Affairs. (2011). 2011 Green Drop Report. Retrieved May 20, 2015, from <https://www.dwa.gov.za/Documents/GD/GDIntro.pdf>
- Department of Water Affairs. (2013). Strategic Overview of the Water Sector in South Africa, 81. Retrieved from <http://nepadwatercoe.org/wp-content/uploads/Strategic-Overview-of-the-Water-Sector-in-South-Africa-2013.pdf>
- Department of Water Affairs and Forestry. (2000). Water Use Authorisation Process. Pretoria.
- Dijk, M. Van, & Vuuren, V. S. (2011). Waterborne Sanitation Operations and Maintenance Guide.
- Eales, K. (2011). Chapter 4. In B. Schreiner & R. Hassan (Eds.), *Transforming Water Management in South Africa: Designing and Implementing a New Policy Framework* (p. 278). Springer Science & Business Media. Retrieved from <https://books.google.com/books?id=fG9VTEilazkC&pgis=1>
- Environmental Management Plans. (n.d.). Retrieved May 20, 2015, from https://www.environment.gov.za/sites/default/files/docs/series12_environmental_managementplans.pdf
- Kidd, M. (2011). Poisoning the right to water in South Africa: What can the law do? *International Journal of Rural Law and Policy*, 0(2004), 1-20. Retrieved from <http://cer.org.za/wp-content/uploads/2011/11/UNE-Paper-Kidd-Final-20110408.pdf>
- Malzbender, D., Earle, A., Deedat, H., Hollingworth, B., & Mkorosi, P. (2009). Review of regulatory aspects of the water services sector. Water Services. doi:WRC Report No. TT 417/09



- Nozaic, D., & Freese, S. (2009). Process Design Manual For Small Wastewater Works.
- Ntombela, C., Masangane, W., Funke, N., & Nortje, K. (2013). Wastewater Treatment: Towards Improved Water Quality to Promote Social and Economic Development. In Sekhukhune District Municipality.
- Revision of General Authorisations in terms of Section 39 of the National Water Act, Pub. L. No. Notice No. 1091 (1998). Republic of South Africa.
- Scheepers, R., & van der Merwe-Botha, M. (2013, May 24). Wastewater treatment plants in South Africa. Infrastructure News, pp. 1-5. Cape Town, South Africa.
- Snyman, H. G., Van Niekerk, A., & Rajasakran, A. (2008). Sustainable wastewater treatment - what has gone wrong and how do we get back on track? DWAF, WRC, Golder Associates, Zitholele Consulting.
- Tyers, L., & Mbatha, D. M. (2010). "What Do We Do To Accelerate Sanitation?"
- Van der Merwe-Botha, M., & Manus, L. (2011). Wastewater Risk Abatement Plan: A W2RAP Guideline- To plan and manage towards safe and complying municipal wastewater collection and treatment in South Africa. Water Research Commission.
- World Bank Group. (2014). Introduction to Wastewater Treatment Processes. Retrieved January 15, 2015, from <http://water.worldbank.org/shw-resource-guide/infrastructure/menu-technical-options/wastewater-treatment>
- Department of Water Affairs and Forestry (2002). An Illustrated Guide to Basic Sewage Purification Operations
- WISA 2002, Handbook for the operation of wastewater treatment works

7 Additional References

- Addendum No1 to Edition 1 (1997) of Permissible Utilisation and Disposal of Sewage Sludge (TT154/01), July 2002
- AGAMA Energy: Integrated Biogas Solutions, Version 2, October 2007
- Boyd, LA & Mbelu, AM, Guideline for the inspection of wastewater treatment works. Water Research Commission WRC TT 375/08, January 2009.
- Brikké, François, Operation and Maintenance of rural water supply and sanitation systems: A Training Package For Managers And Planners, Operation and Maintenance Network of the Water Supply and Sanitation Collaborative Council, IRC International Water and Sanitation Centre, Delft, Netherlands, World Health Organization, Geneva, Switzerland, 2000
- Brown, Nellie J, Health Hazard Manual: Wastewater Treatment Plant and Sewer Workers (ILR Collection Manuals and User Guides) Cornell University ILR School Year 1997,



- Carden and Armitage. 2012. Assessing urban water sustainability in South Africa - not just performance measurement. Water Institute of Southern Africa (WISA) Biennial Conference, Cape Town, 6-10 May 2012.
- Department Of Water Affairs - General And Special Authorisation: Discharge limits and conditions set out in the National Water Act, Government Gazette No. 20526, 8 October 1999
- Department of Water Affairs & Forestry, 1998. Waste Management Series. Minimum Requirements for the Handling, Classification and Disposal of Hazardous Waste.
- Department of Water Affairs & Forestry, 1998. Waste Management Series. Minimum Requirements for the Handling, Classification and Disposal of Hazardous Waste.
- Department of Water Affairs & Forestry, 2002: Sanitation for a Healthy Nation: Sanitation Technology Options: February 2002
- Department of Water Affairs And Forestry, 2002: An Illustrated Guide to Basic Sewage Purification Operations (ISBN 0-620-29884-7)
- Department of Water Affairs and Forestry, Second Edition, 1998. Waste Management Series. Minimum Requirements for Water Monitoring as Waste Management Facilities.
- Department of Water Affairs and Forestry, Second Edition, 1998. Waste Management Series. Minimum Requirements for Water Monitoring as Waste Management Facilities.
- Department of Water Affairs and Forestry: South African Water Quality Guidelines for Coastal Marine Waters: Volume 1 Natural Environment, First Edition, 1995
- Department of Water Affairs and Forestry: The South African Water Quality Guidelines: Volumes 1 to 8: Second Edition, 1996
- Dickens, C & Graham, M 2001. South African Scoring System (SASS) Version 5. Rapid Bioassessment Method for Rivers. Umgeni Water, Pietermaritzburg.
- Durban Metro: Wastewater Management Department, Treatment and Disposal Of Sludge At Wastewater Treatment Works (Guideline / Policy Document No. 5), July 1997
- E-Booklet by Geostar Publishing & Services: Wastewater Treatment Plants: Using the latest advanced immobilized Cell Reactor Technology: <http://www.all-about-wastewatertreatment.com/WastewaterTreatment-AdvancedTechnology.php>
- eThekweni Water And Sanitation Unit, Policy For The Installation Of Privately Owned Low Volume Domestic Sewage Treatment Systems (Guideline / Policy Document No. 12), September 2005
- For information about water quality impacts of poor wastewater treatment:
<https://www.wqms.co.za/infopages/236>
- Golder Associates Africa and Zitholele Consulting, Field Evaluation of the Status and Performance of Wastewater Treatment Plants (Draft Rev 1), Water Research Commission and the Department of Water Affairs and Forestry, March 2006



Government Notice No. 32334, Department Of Health: Regulations Defining The Scope Of The Profession Of Environmental Health: Amendmen (No. R. 698), 26 Junie 2009

Harding, WR. 2010. 'Eutrophication of Impounded Water Resources in South Africa: Descent into Crisis' (Paper presented at the WISA Conference, Durban, April 2010).

Harrison, Ellen Z & McBride, Murray, Case for Caution Revisited: Health and Environmental Impacts of Application of Sewage Sludges to Agricultural Land, Posted at: cwmi.css.cornell.edu/case.pdf September 2008 (updated March 2009)

Herselman, JE & Wade, PW & Steyn, CE & Snyman, HG, An Evaluation Of Dedicated Land Disposal Practices For Sewage Sludge, Water Research Commission, WRC Report No. 1209/1/05, (ISBN No: 1- 77005-288-7), March 2005

Herselman, JE * & Moodley, P ** (*Golder Associates Africa, ** Zitholele Consulting), Guidelines for the Utilisation and Disposal of Wastewater Sludge Volume 4: Requirements for the beneficial use of sludge at high loading rates, Water Research Commission, (WRC Report No. TT 350/08), March 2008

Herselman, JE *, Burger, LW ** and Moodley, P # (* Golder Associates Africa, ** Airshed Planning Professionals, # Zitholele Consulting), Guidelines for the Utilisation and Disposal of Wastewater Sludge Volume 5: Requirements for

Herselman, JE and Snyman, HG (Golder Associates Africa), Guidelines for the Utilisation and Disposal of Wastewater Sludge Volume 3: Requirements for the on-site and off-site disposal of sludge of wastewater sludge, Water Research Commission, (WRC Report No. TT 349/08), March 2007

Herselman, JE, Wade PW, Steyn, CE & Snyman, HG, Water Research Commission "An evaluation of dedicated land disposal practices for sewage sludge ": WRC Report No. 1209/1/05: ISBN No: 1-77005-288- 7: March 2005

Holland, KT, Knapp, JS, Shoesmith, JG, Anaerobic Bacteria, 1st edition, 1987

Jan Theron, SSI Engineers and Environmental Consultants - NMBM W2RAP

Johannesburg Water - Operational Targets, 2010.

Laas, Larry and Botha, Claudia, Conference Paper: Sewage Package Plants: A Viability Or A Liability For New Developments?: Proceedings of the 2004 Water Institute of Southern Africa (WISA) Biennial Conference, 2- 6 May 2004, ISBN: 1-920-01728-3 Cape Town, South Africa, Produced by: Document Transformation Technologies

Lilley, D, Pybus, PJ and Power, PJB (Stewart Scott Inc.), Water Research Commission report "Operating Manual for Biological Nutrient Removal Wastewater Treatment Works" February 1997 (WRC Report No. TT 83/97)

McMillan, PH. 1998. An Invertebrate Habitat Assessment System (IHASv2), for the Rapid Biological Assessment of Rivers and Streams. A CSIR research project, number ENV-P-I 98132 for the Water Resources Management Programme, CSIR.

Metcalf & Eddy Inc, Wastewater Engineering, Treatment and Reuse, 4th Edition, 2003.



- Moeletsi, M., Mazema, H. & Halday, I.: Strategy For Mitigating The Impacts Of Heavy Metals In Wastewater And The Economic And Environmental Implications For The City Of Cape Town: Proceedings of the 2004 Water Institute of Southern Africa (WISA) Biennial Conference, 2-6 May 2004, (ISBN: 1-920-01728-3 Cape Town, South Africa), Produced by: Document Transformation Technologies
- Newmarch, Jocelyn. "Sewage Treatment "Unacceptable"", Business Day (Johannesburg) 28 April 2010.
- NISC 2005-2008 Communicable diseases communique, 2005-2008, monthly National Institute for Communicable Diseases. <http://www.nicd.ac.za/>
- Operational targets as set by Johannesburg Water, 2011
- Permissible Utilisation and Disposal of Sewage Sludge (August 1997 Edition 1): (TT 85/97) August 1997 (PUDSS 1997)
- Persoone, G., Marsalek, B., Blinova, I., Torokne, A., Zarina, D., Manusadzianas, L., Nalecz-Jawecki, G., Tofan, L., Stepanova, N., Tothova, L. & Kolar, B. 1999. A practical and user-friendly toxicity classification system with microbiotests for natural and wastewaters. Fita4 programme.
- Project Validation Report, Methane Recovery in Wastewater Treatment, Pahang, Malaysia, 2010
- Republic of South Africa, Department of Water Affairs and Forestry. 2000. Sub-Series No. MS5.1, Edition 1: Framework for a Water Quality Management Performance Assessment System (WQMPAS). Pretoria
- Risk matrix of the eThekweni Metropolitan Municipality, 2010
- RSA Government Notice 991 of 18 May 1984: Requirements for the purification of wastewater or effluent
- Rush, Joseph D. III, Web based Article: Hazards of Waste, Publication: Fire Chief, Dec 1, 2008 12:00 pm (<http://firechief.com/hazmat/disaster-management/hazards-waste-1208/index.html>)
- Schreiner and Hassan (2011) Transforming Water Management in South Africa: Designing and Implementing a New Policy Framework. Volume 2 of Global Issues in Water Policy. Springer Science & Business Media, 2011
- Snyman, HG and Herselman, JE (Golder Associates Africa), Guidelines for the Utilisation and Disposal of Wastewater Sludge Volume 2: Requirements for the agricultural use of wastewater sludge, Water Research Commission, (WRC Report No. TT 262/06), March 2006
- Snyman, HG and Herselman, JE (Golder Associates Africa), Guidelines for the Utilisation and Disposal of Wastewater Sludge, Volume 1: Selection of Management options, Water Research Commission, (WRC Report No. TT 261/06), March 2006
- Snyman, HG and Winter, D, The Economic, Social, Environmental and Health Impacts of Implementing Sustainable Sludge Management Practices in a Developing Country, Water Research Commission
- Tempelhoff, Johann W N. 'Civil Society and Sanitation Hydropolitics: A Case Study of South Africa's Vaal River Barrage' (2009) 34 Physics and Chemistry of the Earth 164.



The Pennsylvania Department of Environmental Protection (DEP): Webpage document: Tips for Pennsylvania Wastewater Workers on Staying Healthy at Work:
<http://www.dep.state.pa.us/dep/deputate/waterops/Redesign/Subpages/tipsforwwworkers.htm>

The WRC Report on Wastewater Treatment In South Africa: “ From Crisis To Compliance: Final: Report No: 8011/8295/3/P, Submitted to: Water Research Commission and the Department of Water Affairs and Forestry by Golder Associates Africa and Zitholele Consulting, August 2006

Thermal sludge management practices and for commercial products containing sludge, Water Research Commission (WRC Report No. TT 351/08), March 2008

Thirion, C., Mocke, A & Woest, R. 1995. Biological Monitoring of Streams and Rivers Using SASS4: A User Manual. Internal Report N 0000/00/REQ/i 195, of the Institute for Water Quality Studies, Department of Water Affairs and Forestry, Pretoria, South Africa.

Thompson, P and Mjam, S, The development of a generic Water Safety Plan for small community water supply, WRC TT 415/09, August 2009

UNEP/GPA Guidelines on Municipal Wastewater Management: Strategic Action Plan on Municipal Wastewater: Practical Guidance for Implementing the Global Programme of Action for the Protection of the Marine Environment from Land -based Activities (GPA) on Sewage Developed, (Version 2.1), ad UNEP/GC.22/INF/4, December 2002

Van Niekerk, H (2004) South African-UNEP GEMS/Water: Monitoring Programme Design. DWAF-RQS Report Number: N/0000/00/REQ0604. Pretoria. South Africa.

Wastewater Engineering: Treatment and Reuse, Metcalf and Eddy, 2003 49.

Water and Sanitation Audit Report, March 2009

Water Quality Management Series Operational policy for the disposal of land-derived water containing waste to the marine environment of South Africa: Guidance on Implementation: Sub-Series No. MS 13.3 Section 7: Monitoring, Edition 1, 2004

Water Research Commission: Permissible Utilisation and Disposal of Sewage Sludge (TT 85/97) August 1997 (Edition 1)

Web Enablement of a Water Safety Plan (WRC K5/1993) 54. W2RAP of the City of Cape Town, 2011 55. W2RAP of Nelson Mandela Bay Municipality, 2010 56. W2RAP of Steve Tshwete Local Municipality, 2010 57.

www.mapl.com.au/risk/risk2.htm Risk Management



award

The Association for Water and Rural Development

AWARD is a non-profit organisation specialising in participatory, research-based project implementation. Their work addresses issues of sustainability, inequity and poverty by building natural-resource management competence and supporting sustainable livelihoods. One of their current projects, supported by USAID, focuses on the Olifants River and the way in which people living in South Africa and Mozambique depend on the Olifants and its contributing waterways. It aims to improve water security and resource management in support of the healthy ecosystems to sustain livelihoods and resilient economic development in the catchment.

P O Box 1919, Hoedspruit 1380, Limpopo, South Africa

T 015-793 0503 **W** award.org.za

Company Reg. No. 98/03011/08

Non-profit org. Reg. No. 006 - 821

About USAID: RESILIM-O

USAID: RESILIM-O focuses on the Olifants River Basin and the way in which people living in South Africa and Mozambique depend on the Olifants and its contributing waterways. It aims to improve water security and resource management in support of the healthy ecosystems that support livelihoods and resilient economic development in the catchment. The 5-year programme, involving the South African and Mozambican portions of the Olifants catchment, is being implemented by the Association for Water and Rural Development (AWARD) and is funded by USAID Southern Africa.

Copyright © 2018 The Association for Water and Rural Development (AWARD). This material may be used for non-profit and educational purposes. Please contact the authors in this regard, at:

info@award.org.za

The content of this publication does not necessarily reflect the views of AWARD, USAID or the United States Government.

Acknowledgements: Project funding and support

The USAID: RESILIM-O project is funded by the U.S. Agency for International Development under USAID/Southern Africa RESILIENCE IN THE LIMPOPO BASIN PROGRAM (RESILIM). The RESILIM-O project is implemented by the Association for Water and Rural Development (AWARD), in collaboration with partners. Cooperative Agreement nr AID-674-A-13-00008



USAID
FROM THE AMERICAN PEOPLE

SOUTHERN AFRICA